

**SUPERCRITICAL CARBON DIOXIDE EXTRACTION OF LIPIDS FROM RAW
AND BIOCONVERTED RICE BRAN**

A Thesis,

Submitted to the Graduate Faculty of the
Louisiana State University and
Agricultural and Mechanical College
in Partial Fulfillment of the
Requirements for the Degree of
Master of Science in Biological and Agricultural Engineering
in
The Department of Biological and Agricultural Engineering

By
Rohit Badal
B.S., Regional Engineering College, Jalandhar, 1998
December, 2002

ACKNOWLEDGEMENTS

I would like to thank all people who have assisted me in the completion of this project. Thanks to College of Agriculture and LSU Agcenter for funding my project. My advisor, Dr. Terry Walker has always given me the knowledge that will be useful in personal and professional life. I would especially like to thank him for sharing his knowledge on rice bran, Supercritical fluid extraction (SFE), fabrication of high-pressure equipments, biotreatment and analytical methods that was instrumental to this project. I would also like to thank other committee members Dr J. Samuel Godber and Dr. Caye M. Drapcho for their invaluable advice.

Thanks to Zhu Hui for the help in growing *Pythium irregulare* on the rice bran media. I would also like to thank Roy Shroyer, Tom and Don for their help in fabricating the SFE unit. Thanks to Dr. Chang-Sik Kim and Paresch Patel for their help in fixing the leaks of the SFE unit.

Many thanks to my parents, R.S Badal and Saroj Badal, brother Rahul Badal, sister Rachna Badal for their support and love. Lastly, I would like to thank my friends and colleagues for their encouragement and help.

TABLE OF CONTENTS

ACKNOWLEDGEMENTS	ii
LIST OF TABLES.....	v
LIST OF FIGURES.....	vi
ABSTRACT.....	vii
CHAPTER 1	
INTRODUCTION.....	1
CHAPTER 2	
LITERATURE REVIEW.....	4
2.1 Supercritical Fluid Extraction	4
2.2. Carbon Dioxide Use in Extraction	6
2.3. Facts about Rice Bran	8
2.4. Fatty Acids	8
2.5. Desaturase Metabolism	12
2.6. Stabilization Techniques	14
2.7. Economics	14
2.8. Mathematical Modeling	15
CHAPTER 3	
MATERIALS AND METHODS	19
3.1 Rice Processing	19
3.2. Biotreatment	21
3.3. Supercritical Fluid Extraction	21
3.3.1. Determination of Diffusivity	25
3.4. Soxhlet Extraction.....	25
3.5. Gravimetric Method	25
3.6. Gas Chromatography Analysis.....	25
3.6.1. External Standard Method.....	26
3.6.2. Effect of Dilution in Fatty Acid Analysis	28
CHAPTER 4	
RESULTS AND DISCUSSION	29
4.1. Total Oil Analysis	29
4.1.1. Effect of Extraction Method.....	29
4.1.1.1. Soxhlet Extraction	32
4.1.1.2. Supercritical Fluid Extraction	32
4.1.2. Effect of Biotreatment.....	32
4.1.3. Effect of Particle Size.....	35
4.1.3.1. Diffusivity Measurement.....	35
4.2. Fatty Acid Methyl Ester Analysis	37

4.2.1. Soxhlet Method	39
4.2.1.1. Effect of Biotreatment.....	39
4.2.1.2. Effect of Particle Size.....	39
4.2.2. Supercritical Fluid Extraction	39
4.2.2.1. Effect of Time	39
4.2.2.2 Effect of Biotreatment.....	40
4.2.2.3. Effect of Particle Size.....	40
 CHAPTER 5	
CONCLUSIONS AND RECOMMENDATIONS.....	44
5.1. Conclusions	44
5.2. Recommendations	45
 REFERENCES.....	47
 APPENDIX A	
OPERATING GUIDELINE FOR SFE.....	49
 APPENDIX B	
STANDARD OPERATING PROCEDURE FOR GAS CHROMATOGRAPHY.....	52
 APPENDIX C	
CALCULATIONS	58
 APPENDIX D	
PRELIMINARY SFE AND SOXHLET DATA.....	61
 APPENDIX E	
SAS PROGRAMS	64
 VITA.....	72

LIST OF TABLES

Table 2.1 Composition of stabilized rice bran	9
Table 3.1. Temperature program for free fatty acid analysis	27
Table 4.1.1 Composition (weight %) of rice bran oil.....	38
Table 4.1.2 Composition (weight %) of fungal oil	38

LIST OF FIGURES

Figure 1.1. Processing steps leading to the source of rice bran and white rice	2
Figure 2.1. Pressure-Temperature (P-T) phase diagram of a one-component fluid	5
Figure 2.2 Viscosity as a function of temperature and pressure	7
Figure 2.3. Representatives of the ω -6 and ω -3 fatty acid families	11
Figure 2.4. Desaturase metabolism of gamma and alpha linolenic acids	13
Figure 2.5. Rice processing showing the potential added value with each steps.....	16
Figure 3.1. Experimental plan of the present study.....	20
Figure 3.2. Schematic diagram of laboratory scale SFE unit used in this study showing.....	22
Figure 3.3. Laboratory scale SFE unit used in present study.....	23
Figure 4.1 Samples of oil extracted by different extraction methods	30
Figure 4.2. Samples of Big bioconverted bran before and after the SFE.....	31
Figure 4.3. Oil yield (percentage) by Soxhlet extraction	33
Figure 4.4. Oil yield (percentage) by SFE	33
Figure 4.5. Cumulative oil yield per gram of CO ₂ consumed for SFE	34
Figure 4.6. Cumulative oil yield at different time of extraction	36
Figure 4.7. Cumulative oil yield per gram of carbon dioxide consumed.....	36
Figure 4.8. Yield of EPA and AA at different times of extraction	41
Figure 4.9. Fatty acid distribution after 15 minutes of SFE.....	43
Figure 5.1 Present experiment plan.....	46
Figure 5.2 Proposed experimental plan.....	46

ABSTRACT

Rice bran is often discarded despite its nutritional value because the oil in rice bran easily becomes rancid. This has necessitated the search for a method for utilizing the rice bran. The present study involves the application of supercritical fluid extraction (SFE) and bioprocessing (microbial growth on rice bran media) for increasing the value of the rice bran to produce products of high value (nutraceuticals) with superior health benefit. This study was focused on determining the effect of particle size (>48 mesh and 16-48 mesh) and biotreatment on the yield and quality of rice bran oil. SFE technique (40°C, 4000 psi, 200 standard cm³ per min) was applied for extracting oil from raw and bioconverted rice bran and kinetic data was collected. Fatty acid methyl ester (FAME) analysis was accomplished with gas chromatography to determine fatty acid distribution in the raw and bioconverted rice bran. Statistical analysis was done to determine the effect of the parameters (particle size, biotreatment and time) on the oil yield and (FAME) composition. The results show SFE yielded 51.5% of the total ether extractable oil in 2 hours from small particle size rice bran. FAME analysis showed that Eicosapentaenoic acid, (1.8 FAME wt %) and Arachidonic acid (0.67 FAME wt %) produced during the biotreatment was extracted by SFE. The statistical analysis indicated oil yield was a function of particle size for SFE ($p = 0.0013$), but not for Soxhlet extraction.

CHAPTER 1

INTRODUCTION

Rice is one of the widely used crops in the world for human consumption. More than 500 million metric tons of rice is produced per year (1). Paddy rice is milled to separate the rice kernel from the hull and bran. Rice bran contains about 18-22 % rice bran oil. Figure 1.1 shows the processing steps leading to the source of rice bran. Rice bran is rich in vitamins, minerals, amino acids, essential fatty acids and antioxidant nutrients.

Rice bran is used by the food industry in the production of baked goods, snacks, crackers, breads, and cereals (1). Rice bran oil has an impressive nutritional quality, which makes it suitable for nutraceutical production. Nutraceuticals are defined as “a food or naturally occurring food supplement thought to have a beneficial effect on human health” (2). Researchers at the National Center for Agricultural Utilization Research (NCAUR) in Peoria, Illinois used supercritical fluid extraction (SFE) technique to extract the oil from rice bran, corn fiber and soybeans (3). Rice bran is often discarded or sold as an animal feed because of the rancidity created by the hydrolysis of oil, which is catalyzed by lipase enzymes (4). Rice bran can be used for human consumption if the concentration of the free fatty acids is less than 5 % (1). Supercritical fluid extraction and solvent extraction are effective techniques for removal of rice bran oil. SFE has the advantage of unique properties of supercritical fluids that extract solvent-free partially refined oil when compared to liquid solvent extraction (5,6).

Previous studies have shown the feasibility of extraction of rice bran oil by SFE techniques (7, 8). Efficient extraction of rice bran oil may be accomplished at 4000 psi and 40 °C with supercritical carbon dioxide because CO₂ density results in adequate solvent power (6). The amount of extractable oil depends on the variety of rice bran, extraction

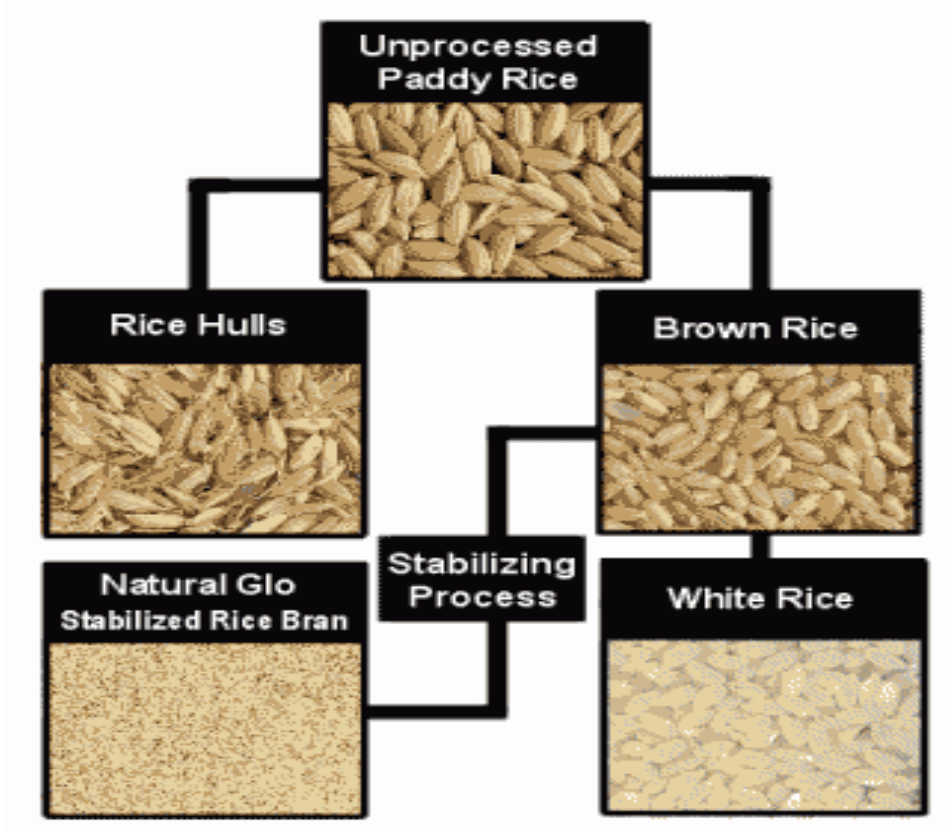

Figure 1.1. Processing steps leading to the source of rice bran and white rice (1).

conditions, addition of entrainer and milling procedure. Methanol or ethanol is commonly used as an entrainer for increasing the extraction of polar compounds. Other factors that affect the extraction yield are raw material characteristics (particle size and variety of rice bran), bioconversion, stabilization techniques, moisture content and flow rate.

The biotreatment of rice bran by *Pythium irregulare* produces fungal oil, which contains ω -3 fatty acids and other essential fatty acids like EPA (8). Other fungi genus e.g. *Mortierella* also produces EPA (8). The present study determined the effect of particle size and biotreatment using *P. irregulare* ATCC 10951 on the yield and quality of rice bran oil. Rice bran with two particle sizes (>48 mesh and 16-48 mesh) was considered for the study. Biotreatment was accomplished with the bioconversion of rice bran using *Pythium irregulare* grown for 7 days at 24 °C followed by freeze drying. SFE data was collected with time for raw rice bran and bioconverted rice bran. Soxhlet extractions were conducted as a standard test to determine the total solvent extractable oil using the standard AOAC method.

Present experiments are directed towards finding an engineering solution for increasing the value to the rice bran by the potential utilization of the byproduct material by fermentation to produce a product of high value.

The goal of the project was to study the effect of particle size and biotreatment on the yield and quality of rice bran oil. The specific objectives were

- Design, fabrication and operation of SFE unit
- Determination of fatty acid content of the oil extracted from raw and bioconverted rice bran by gas chromatography.
- Determination of diffusivity for modeling of the SFE process.

CHAPTER 2

LITERATURE REVIEW

2.1 Supercritical Fluid Extraction

Supercritical fluid extraction (SFE) is a separation technology that uses supercritical fluid solvent. A phase diagram is instrumental for understanding the process of SFE. A phase diagram (Figure 2.1) of a fluid shows the state of a substance at different pressures and temperatures. Every fluid is characterized by a critical point, which is defined in terms of the critical temperature and critical pressure. Fluids cannot be liquefied above the critical temperature, regardless of the pressure applied but may reach the density close to the liquid state (2). A fluid is considered supercritical when its thermodynamic state is greater than its critical point. For example, CO₂ is supercritical above 304.2° K and 7.3 MPa. Supercritical fluids (SCFs) have infinite compressibility because the coexistent vapor and liquid phase have the same pressure but different molar volume (9).

SCFs have desirable properties that make it suitable for challenging extraction processes. Properties of SCFs change with a slight variation in pressure or temperature near the critical point (9). They exhibit high density, like liquids, and low viscosity similar to gases. High densities of SCFs contribute to greater solubilization of compounds while low viscosity enables penetration in solids and allows flow with less friction. Surface tension and heat of vaporization significantly decreases for SCFs (9).

Supercritical carbon dioxide is one of the commonly used SCFs. It has gained importance as a “green” or environmentally friendly solvent. Supercritical CO₂ is considered the most promising replacement for conventionally used solvents like hexane.

Addition of a solvent modifier like ethanol can change the selectivity of compounds in carbon dioxide, which can be useful for selective separation. CO₂ may be recycled by

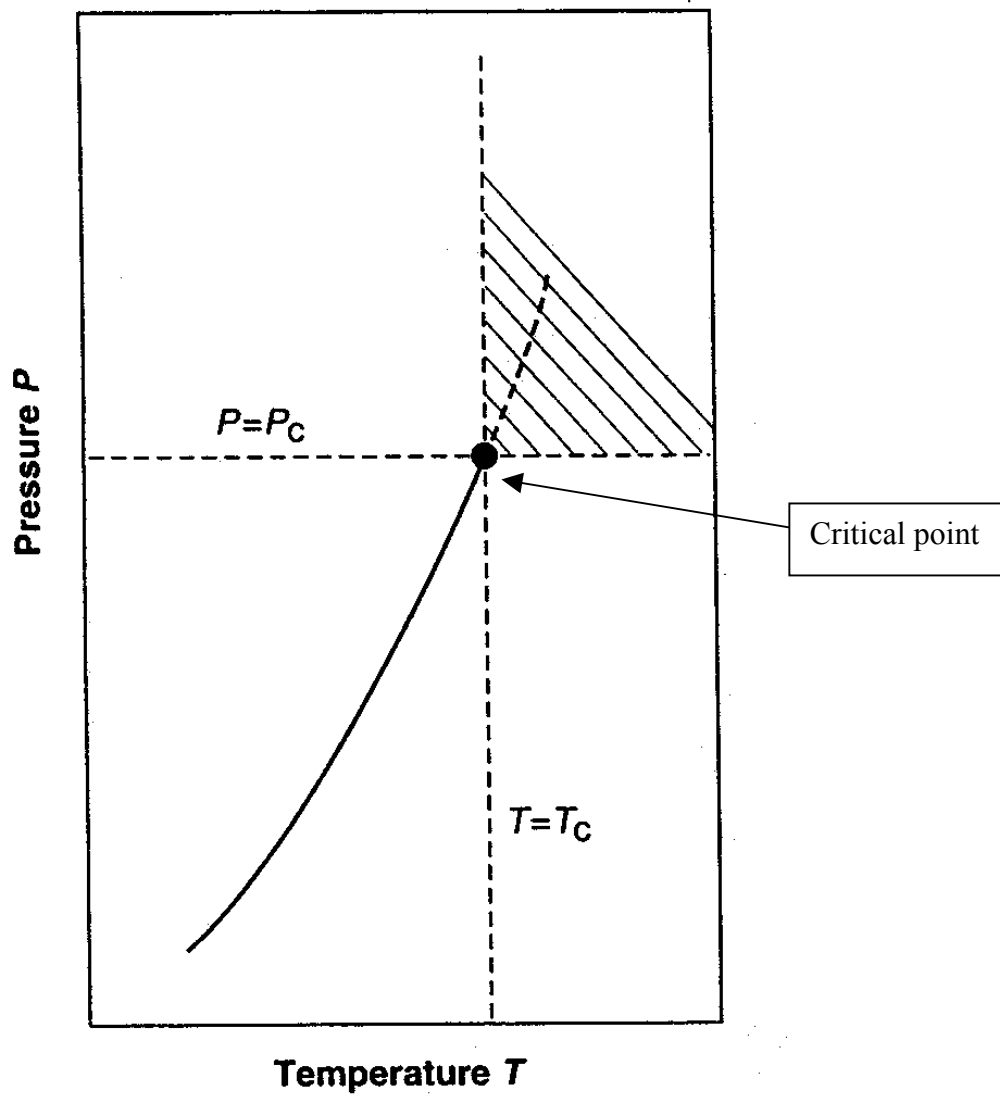

Figure 2.1. Pressure-Temperature (P-T) phase diagram of a one-component fluid (9).

filtration and repressurization. Control of solvent strength by adjusting solvent properties and environmental compatibility makes Supercritical CO₂ useful in processing industries such as food industry, polymer processing and petroleum industry.

Properties of supercritical fluids can be adjusted by controlling density or pressure. Viscosity of a fluid increases abruptly from the vapor phase to liquid phase when plotted against the pressure (Figure 2.2.a). However, the plot of viscosity against the density shows no abruptness because this scale does not show the weak critical divergence of viscosity (Figure 2.2.b). Density changes sharply with pressure in the supercritical region due to a large compressibility. Process engineers generally avoid this region of large compressibility because the process control or tuning becomes more challenging, where a slight change of pressure can cause appreciable effects (9). However, if the process control is achieved, considerable fractionation capabilities are possible particularly for lower molecular weight compounds with greater volatility near critical point.

Density may be determined from an equation of state (EOS), which describes vapor pressure and the distribution coefficient of liquid mixtures. An EOS is the mathematical relation between volume, pressure, temperature, and composition (10). The capability of EOS to describe density is limited and their analytical behavior at the critical point is not well established. Experiments performed using SCFs face the challenge of adequate knowledge of density behavior. Density, enthalpy, entropy and dielectric constant of the supercritical fluid are intermediate between those of a vapor and liquid but isothermal compressibility, isobaric expansion coefficient and heat capacity are not intermediate between those of a vapor and liquid (10).

2.2. Carbon Dioxide Use in Extraction

Many biological compounds are thermally labile and nonvolatile in nature (11). Carbon dioxide is an ideal solvent for the extraction of biological compounds because of

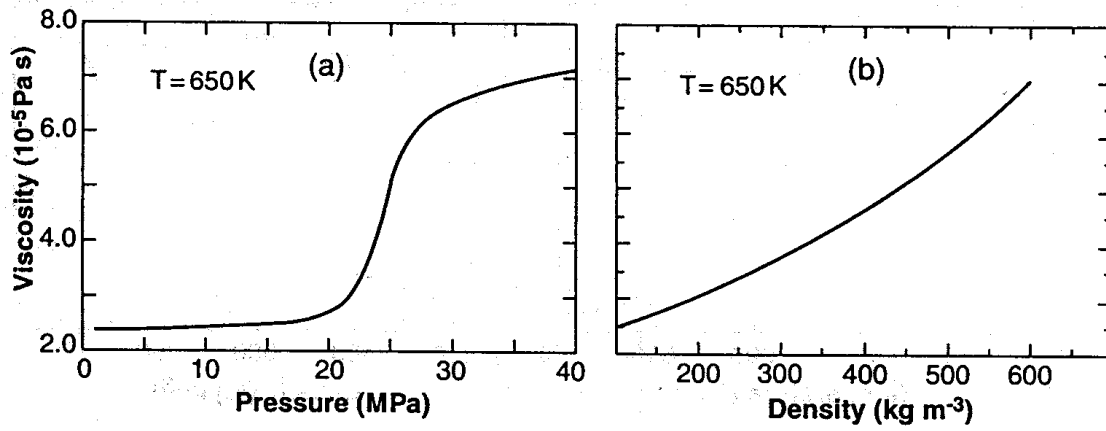

Figure 2.2 (a) Viscosity as a function of pressure on supercritical isotherm at 650 K. (b) viscosity as a function of density on the supercritical isotherm.

its moderate critical temperature (31 °C). Apart from a low critical temperature, CO₂ is also economical, non-toxic, inert and nonflammable. CO₂ is environment friendly compared to toxic and carcinogenic solvents such as hexane, which makes it an excellent alternative to hexane. CO₂ is a good solvent for extracting lipid soluble compounds and enables a high recovery (12,13).

2.3. Facts about Rice Bran

Rice bran is a rich natural source of vitamins, minerals and antioxidants (1) and is recommended for the replacement of saturated fat in human and animal diets. Presence of unsaponifiable constituents such as oryzanol has been shown to reduce blood cholesterol levels (14). The consumption of 100 g of rice bran per day has been reported to significantly reduce levels of plasma cholesterol (14). Rice bran and oil have industrial potential in the cosmetic industries and for snack food production with a good fry life and a nut like flavor (15). Production of margarine from rice bran oil has health benefits with reduced saturated fats and trans-fatty acids.

The composition of rice bran oil is similar to that of other vegetable oils and it roughly contains 18 % saturated fatty acids, 44 % monounsaturated fatty acids and 38 % polyunsaturated fatty acids. Rice bran oil contains essential fatty acids such as linolenic acid, linoleic acid, antioxidants such as γ -oryzanol and related ferulic acids esters, which have significant nutraceutical value (14). Composition of fatty acids extracted from rice bran varies with the type of rice bran used. Table 2.1 shows the typical composition in stabilized rice bran.

2.4. Fatty Acids

Fatty acids are organic compounds that contain a carboxyl group at one end and a methyl group at the other end. They are produced as the end product of fat digestion. Based

Table 2.1 Composition of stabilized rice bran (1)

Content	Composition (weight %)
Protein	13 – 16
Oil	18-22
Moisture	5 – 8
Ash	6 - 9
Crude Fiber	6 – 9
Dietary Fiber	25 – 35
Free Fatty Acids	1.5 – 2.5

on the degree of saturation, fatty acids may be divided into saturated and unsaturated fatty acids. Saturated fatty acids do not contain double bonds between carbon atoms while unsaturated fatty acids contain one or more double bonds between carbon atoms (16).

Free fatty acids are formed by the hydrolysis of the fat. Free fatty acid concentration in the rice bran oil determines suitability of the oil for human consumption. Rice bran is suitable for human consumption if the concentration of the free fatty acid (FFA) is less than 5 % by weight (1). Lipase activity significantly increases the free fatty acid concentration by hydrolyzing the oil in germ. Lipases are a “group of enzymes that catalyze the hydrolysis of fats into glycerol and fatty acids” (2). Moisture, temperature and pH affect lipase activity. Previous studies show that the concentration of free fatty acids reaches 7-8 % within 24 hours of milling and increases by 4-5 % per day (1). These free fatty acids may be removed from rice bran oil with SFE using higher temperatures in a stripping section (17). The concentration of free fatty acids was found to increase with time (17).

Fatty acids can be divided into two groups on the basis of their synthesis in the human body. Essential fatty acids, like *cis*-linoleic acid, arachidonic acid (AA) and linolenic acid, cannot be synthesised inside the human body and must be supplied externally from the diet. Non-essential fatty acids, like oleic acid, can be synthesised in the body. Two types of essential unsaturated fatty acids are designated by the position of the terminal double bond (ω -6 and ω -3). The ω indicates the position of the first double bond that starts from either 6th (ω -6) or 3rd (ω -3) carbon atom from the methyl end, respectively (18). Figure 2.3 shows the main representatives ω -6 and ω -3 fatty acids. These compounds influence most of the neuro-physiological and regulatory functions (hormonal and metabolic) in the body (8). Fatty acids have several important functions in the body like building blocks of the cell membrane and maintenance of the fluidity of the cell membrane. They facilitate the exchange of oxygen and nutrients across the cell membrane (16).

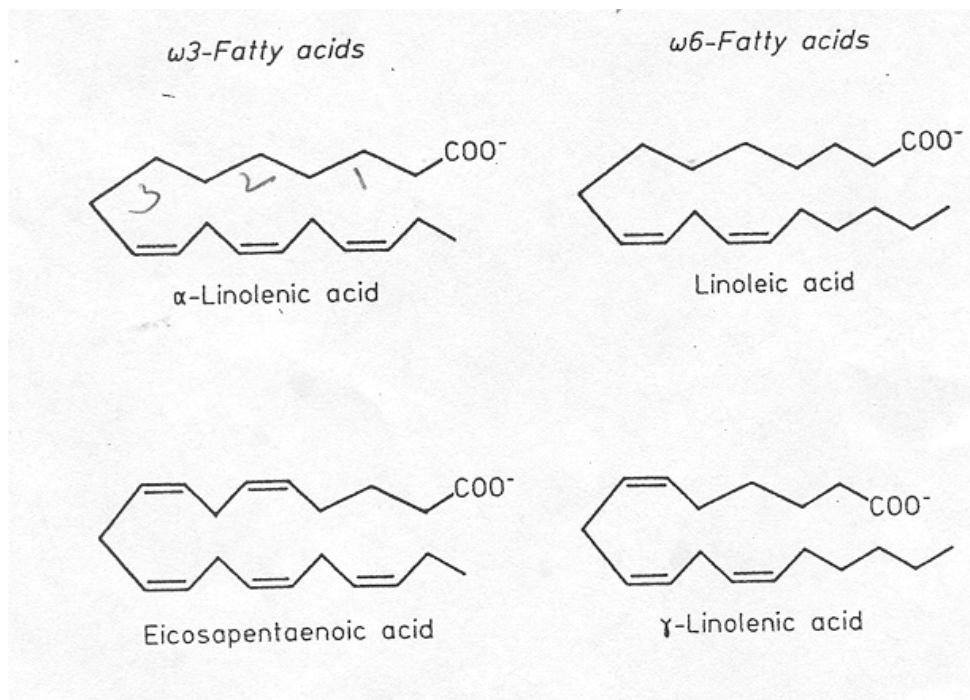

Figure 2.3. Representatives of the ω -6 and ω -3 fatty acid families (18)

2.5. Desaturase Metabolism

Metabolism is defined as “the chemical processes occurring within a living cell or organism that are necessary for the maintenance of life”(2). In metabolism some substances are broken down to yield energy for vital processes while other substances, necessary for life, are synthesized. Desaturase metabolism (Figure 2.4) has two main routes. The ω -6 route forms AA from linoleic acid and the ω -3 route forms EPA from α -linoleic acid. Previous studies show that AA can be converted to EPA at low temperatures due to activation of Δ -5 desaturase involved in EPA formation (19). Mammalian systems produce EPA from ω -3 route so EPA can be produced in either way. The production of EPA from the ω -3 route is of practical significance because several kinds of natural oil, like rice bran oil, containing α -linolenic acid and thus they can be a good source of EPA.

The first step in ω -6 route is the formation of γ -linolenic acid (GLA) by desaturation of linoleic acid by Δ -6 desaturase. Dihomo- γ -linolenic acid (DGLA) and arachidonic acid (AA) are produced successively during the metabolism (20). Desaturation of 18:2(ω -6) and 18:3(ω -3) by Δ -6 desaturase is the rate-limiting step in the production of 20:4(ω -6) and 22:6(ω -3) (19). These fatty acids can be metabolized further to produce a variety of essential intermediate compounds.

The ω -3 route involves three reactions. The first reaction is Δ 6- desaturation of α -linolenic acid to the octadecatetraenoic acid(C 18:4 ω -3). This reaction is followed by the elongation of octadecatetraenoic acid to eicosatetraenoic acid (C 20:4 ω -3). The final reaction is the formation of EPA from the eicosatetraenoic acid by Δ 5- desaturation. The ω -3 and ω -6 routes show that Δ 5-desaturase is not only important for linoleic acid metabolism, but also important for the synthesis of eicosapentaenoic acid (EPA) and docosahexaenoic acid (DHA) (Figure 2.4).

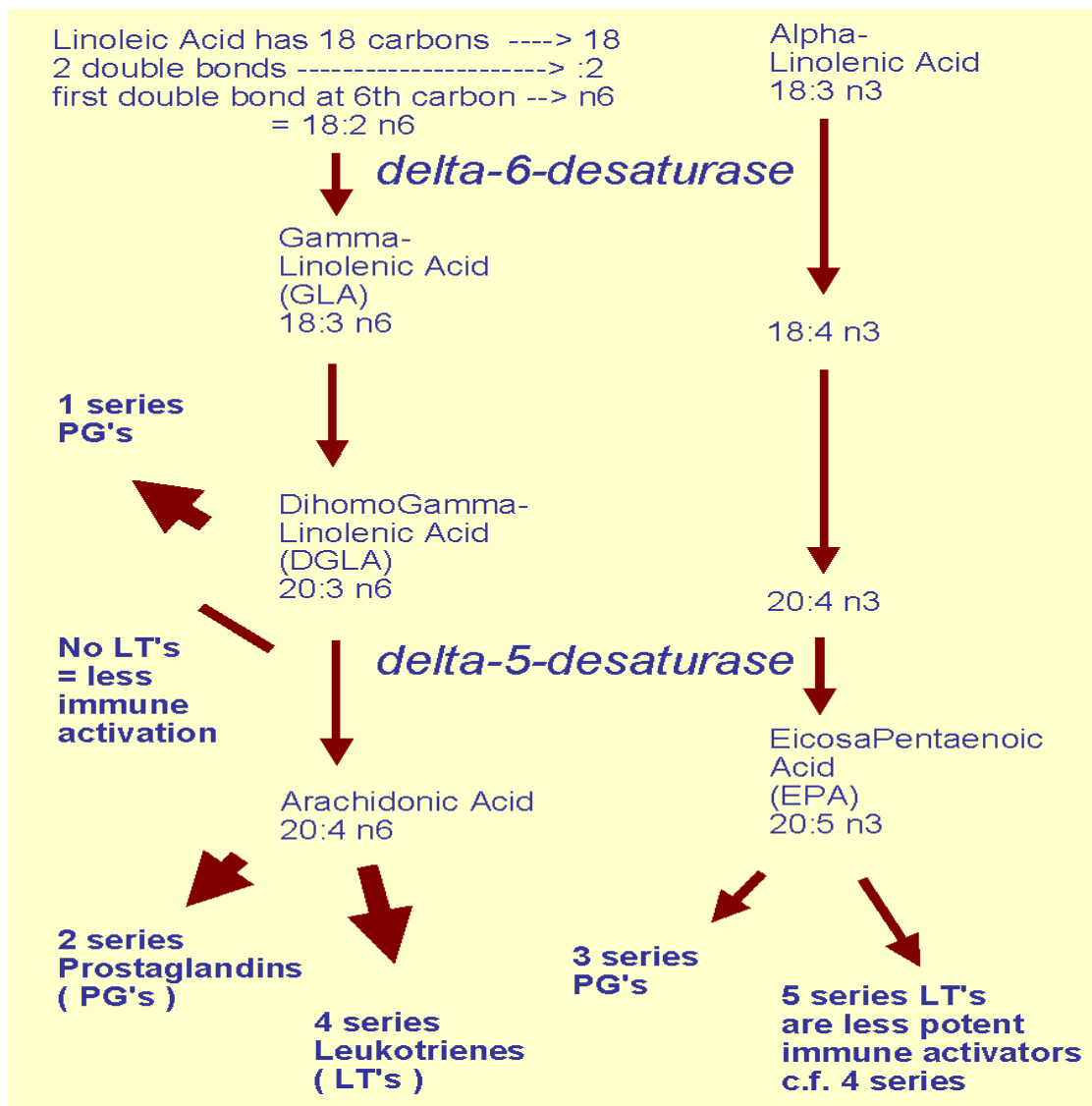

Figure 2.4. Desaturase metabolism of gamma and alpha linolenic acids (20).

The ratio of EPA and AA is also an important factor because it has been found that production of EPA elevates with the repressed production of AA and vice versa. This can be explained by the sharing of the enzymes by two routes. The α -linoleic acid and linoleic acid are the two substrates, which can compete with each other for the enzyme.

2.6. Stabilization Techniques

Rice bran is stabilized to control the concentration of free fatty acids. The commonly used stabilization techniques are heat, cold and acid stabilization. Acid stabilization uses acids like hydrochloric acid for controlling the lipase activity. Heat stabilization is accomplished commercially by wet or dry heating methods i.e. dry extrusion, microwave, and hot air (21). Application of heat at 110 °C deactivates the lipase enzyme (21). There are certain processes used in the industries for stabilization like parboiling. Cold stabilization is accomplished by keeping the rice bran in airtight polythene bags at 0 °C or below (21). Researches have found that the stabilization techniques had an effect on the physio-chemical properties, fatty acid composition and oil extractability (21).

2.7. Economics

The objective of the current project was to add value to rice bran through processing. The price of rice is determined by the concept of supply and demand. Internationally, rice prices have dropped since 1998. Total domestic supply of rice is projected to be 252.5 million cwt and total domestic usage is projected to be 201.1 million quintal.

Increased supply and low international prices of rice are weakening the price of rice in the U.S. (22). Global ending stocks have declined in 2000-01 and 2001-02 and U.S. ending stocks are largest since 1987. Increased production has increased the stocks to use ratio to 22.2%. The projected season average farm price (SAFP) for 2001-02 is lowest since 1986-87 (\$4.10 to \$4.4 per cwt), which calls for an alternative approach to be implemented by the rice industry. Value added processing is one alternative that can generate extra

revenue for the farmers and rice industry. The current project applies SFE and bioprocess techniques to increase the value to rice bran with products that potentially impact the health food industry and may be useful for medical research. Figure 2.5 shows the significance of the value added processing.

Initial cost of SFE operations is high because of the high fixed cost involved with the high-pressure equipment commonly made up of expensive stainless steel. Recirculation of the solvent reduces the solvent use in the process. However, appreciable mass transfer resistance is encountered during extraction of rice bran oil and other natural compounds, which results in high recompression cost (11). SFE has lower energy costs than conventional separation system because of reduced extraction rates and single step desolventization accomplished by depressurization (11).

2.8. Mathematical Modeling

Reliable mass transfer models are required to operate an extraction plant at the optimum conditions. The system may be better understood by the application of mathematical modeling and simulation. Many challenges are involved in mass transfer modeling of biological compounds due to complexity of the structure (23). Mathematical models are designed using empirical kinetics equations, analogy between heat & mass transfer and differential mass balances. Diffusion is derived by Fick's law, which states that flux is proportional to concentration gradient and that diffusion of a compound occurs in the in the direction of decreasing concentration.

Fick's second law for a spherical geometry is

$$\frac{\partial C}{\partial t} = D \left(\frac{\partial^2 C}{\partial r^2} + \frac{2}{r} \frac{\partial C}{\partial r} \right) \quad (2.1)$$

Initial condition: $C = C_0$ at $t = 0$ (2.2)

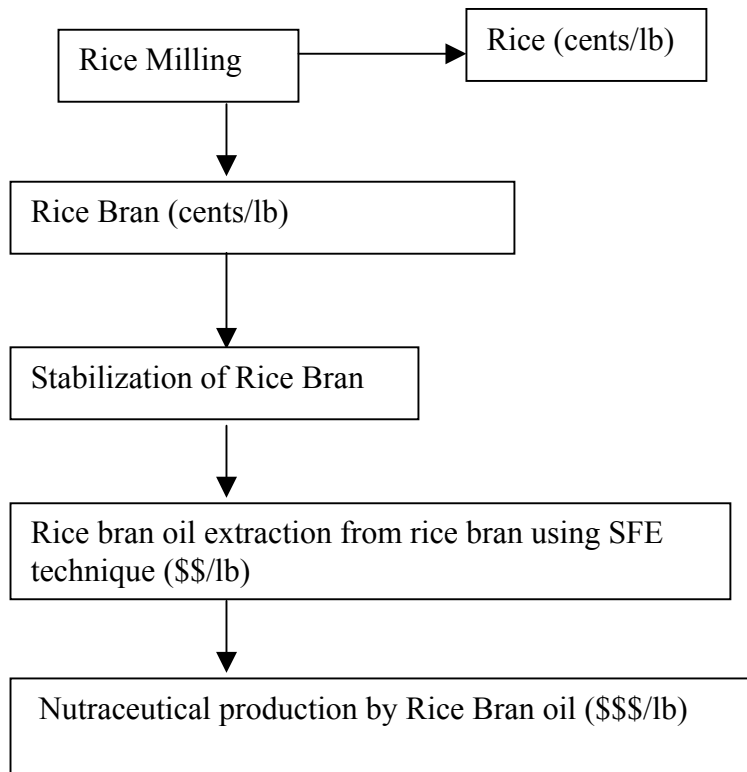

Figure 2.5. Rice processing showing the potential added value with each steps

Boundary conditions: $\frac{dC}{dr} = 0$ at $r = 0$ (2.3)

$$C = C_{\infty} \text{ at } r = R \text{ and } t = \infty \quad (2.4)$$

- where
- C = the concentration of solute in the sphere at time t and position r
 - C_{∞} = the concentration of solute at the surface after infinite time (assumed to equal bulk flow concentration for high convective mass transfer conditions)
 - D = the diffusion coefficient
 - r = distance from center of sphere
 - R = the radius of the sphere
 - t = time

The equation 2.4 can be solved analytically (24) to obtain the following solution

$$\frac{M_t}{M_{\infty}} = 1 - \frac{6}{\pi^2} \sum_{n=1}^{\infty} \frac{1}{n^2} \exp \left(-\frac{Dn^2 \pi^2 t}{r^2} \right) \quad (2.5)$$

Where M_t Total amount of solute diffused from sphere at time t

M_{∞} Total amount of solute

n Number of iterations

Diffusivity of the biological materials is an important design property tested to optimize extraction efficiency in the system. It is a property of material that depends on temperature, pressure, concentration, and nature of compound diffusing, but is independent of radius or particle size in homogenous materials (5). Total mass flux of a solute is composed of diffusive flux and bulk flow. Diffusivity is best determined when the concentration gradient is the main driving force for the extraction, which often occurs at the

later stages of extraction done at high flow rates when component surface concentrations are low enough to diminish convective effects.

CHAPTER 3

MATERIALS AND METHODS

Experiments were designed for studying the effect of biotreatment and particle size on the yield and quality of rice bran oil. Sixteen experiments were conducted during the study, which were divided equally in Soxhlet extraction and SFE runs. The experimental plan of the present study is shown in Figure 3.1. SFE experimental runs utilized an average sample size of 6 g of rice bran, while average sample size of 14 g was used for the Soxhlet extraction except for the small bioconverted bran, where 4.91 g of sample was used because of the limited availability of the sample (small bioconverted bran). A sample size of 6 g was used for SFE because the maximum capacity of the extraction cell used in SFE was 6 g.

Extraction kinetics of the system was studied by taking data at different times for the SFE experimental runs. Soxhlet extractions were performed as a standard test for the determination of total extractable oil.

3.1 Rice Processing

The experiments utilized Cocodrie rice as raw material provided by LSU Crowley rice station. Rice was milled in the Satake Rice mill located in the LSU Biological and Agricultural Engineering Department.

Rice bran used for both bioconverted and untreated experiments was stabilized by microwave heat stabilization. Milled rice bran was placed in a microwave and heated to an average temperature of 102 ° C. Rice bran was placed in a rectangular plastic container, spread uniformly and mixed manually (mixing the rice bran by hands) to ensure uniform heating of bran. The temperature at different points inside the container was recorded by mercury thermometer. Rice bran was heated and temperature was recorded repeatedly until

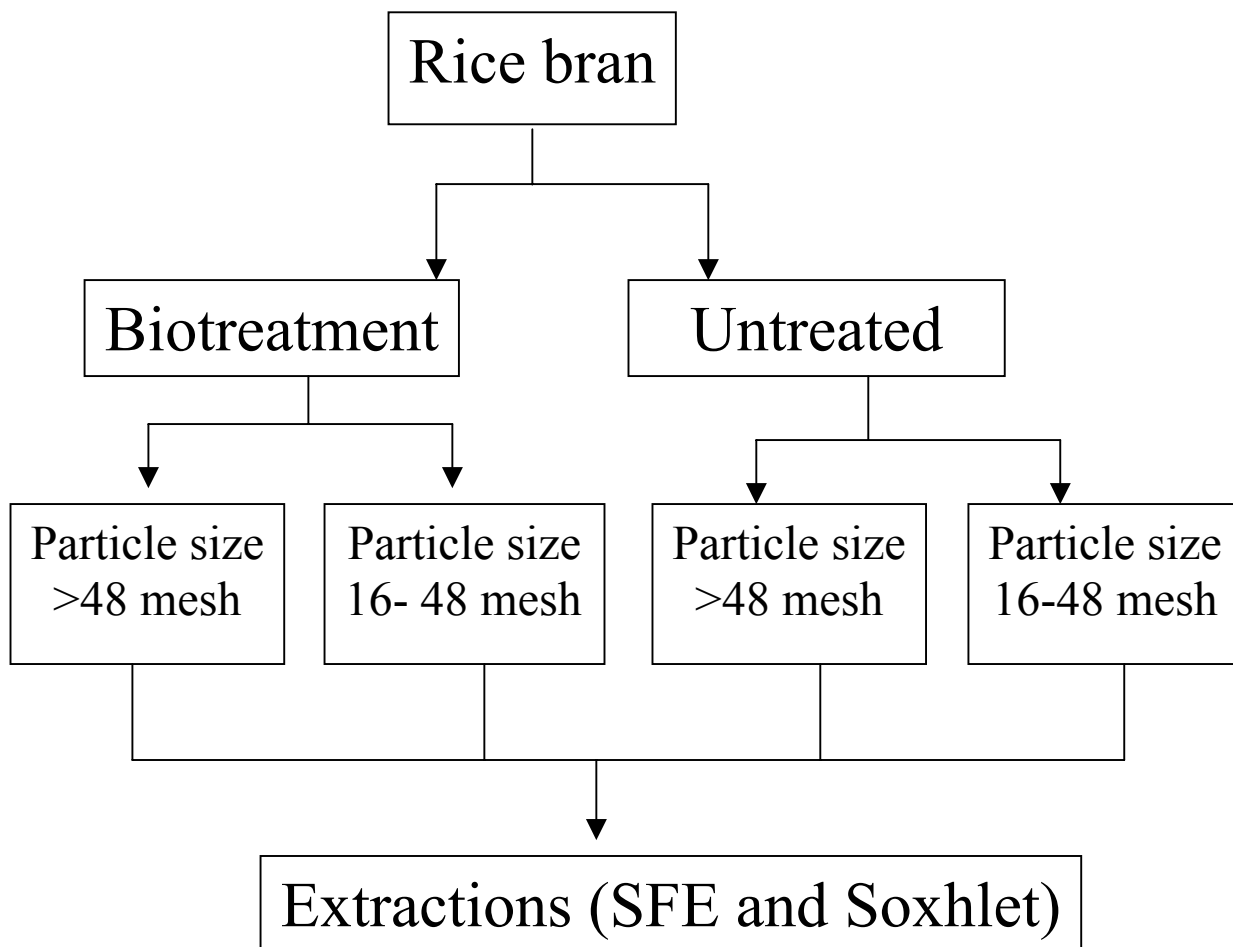

Figure 3.1. Experimental plan of the present study

the temperature of the entire rice bran is above 102° C. It took approximately 25 minutes to stabilize 5 lbs of rice bran. Moisture content after stabilization was approximately 7% wet basis.

Rice bran was refrigerated after stabilization. Rice bran used in untreated experiments (no biotreatment) was divided into two-particle sizes including small particle size bran with an average size greater than 48 mesh and big particle size bran with an average size of 32 mesh, which was accomplished by isolating the fractions between 2 shaker sieves of 16 and 48 mesh size.

3.2. Biotreatment

Pythium irregulare was grown on rice bran medium using the procedure from Hui et al. (25). A 5 % mixture is made by adding 5 g of rice bran to 100 g of water in a flask. *Pythium irregulare* was inoculated to the mixture placed in 250 ml Erlenmeyer flasks, capped with sterile sponge, and incubated for 7 days at 25 ° C in a New Brunswick shaker bath set at 150 rpm (25). The biomass after 7 days was dried in a vacuum dryer to approximately 7 % moisture content wet basis. The dried biomass was grounded and sieved into two particle sizes, > 48 mesh and 16 – 48 mesh. Specific determination of the fatty acid profile for production of EPA and AA from rice bran biomass was emphasized.

3.3. Supercritical Fluid Extraction

Extractions were accomplished in the SFE unit (Figure 3.2 and Figure 3.3) at 40 ° C and 4000 psi. The extraction conditions were found to be optimum based on the work of previous researchers (7, 8). A 300 ml/min-flow rate was chosen based on the previous studies with oil extraction from soy meal and *Pythium irregulare* (8). Figure 3.2 shows the schematic diagram of laboratory scale SFE unit used in the present study, and Figure 3.3 shows the experimental setup of SFE unit. The sample, rice bran or bioconverted rice bran,

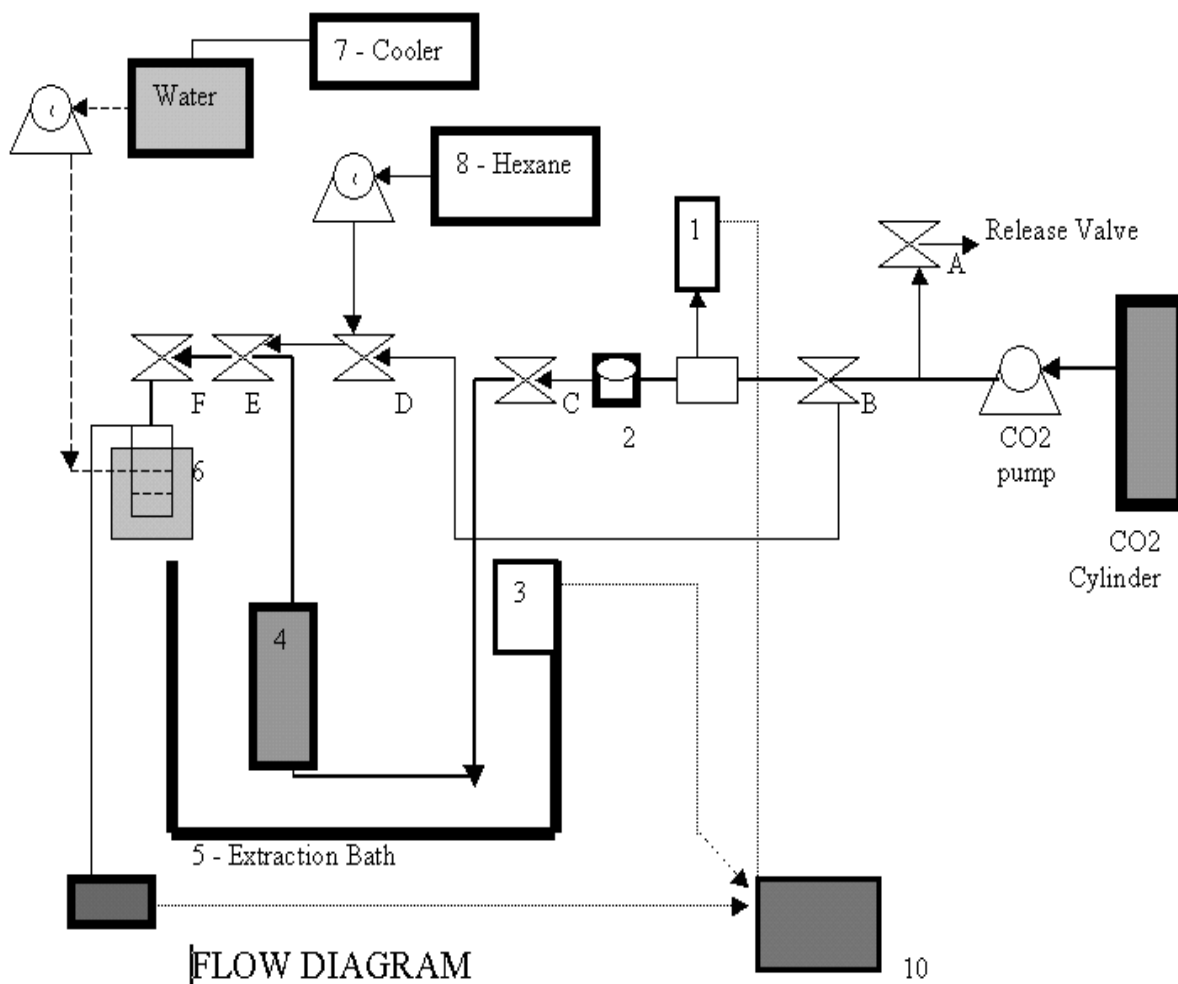

Figure 3.2. Schematic diagram of laboratory scale SFE unit used in this study showing 1. Pressure measurement device, 2. Safety release valve, 3. Bath Heater, 4. Extraction Cell, 5. Extraction Bath, 6. Sample collection unit, 7. Cooler, 8. Pumps – CO₂, water and hexane pump, 9. Flow meter, 10. Data acquisition unit.



Figure 3.3. Laboratory scale SFE unit used in present study

is mixed with the glass beads (24 g) and filled in the extractor. Temperature in the extractor was maintained at 40 ° C by submerging the extractor in a water bath that was heated by submersible electrical heater equipped with the PID control. Ultrahigh pure (grade 2.8) carbon dioxide was pressurized by Isco 260-D syringe pump to a constant pressure of 27.6 MPa. Valves A, D, and E were completely closed before starting the extraction, while valves B and C were completely opened so that CO₂ can flow in the direction of the valve B-C-E. After attending the extraction conditions, Valves E and F were partially opened for adjusting the flow rate of CO₂ to 300 ml/min at the sample collection point, which was a glass tube filled with hexane and cooled by 5° C circulating cold water or ice water. CO₂ flowed upward through the extraction cell, which was vertically mounted and supported by clamps. Oil diffuses from rice bran to CO₂ and was collected in the sample collection unit. The separation of the oil from supercritical CO₂ was accomplished by reduction of temperature to 5 ° C and pressure to atmospheric pressure at the sample collection point. CO₂ was vented off from the top and passed through a flow meter (Omega, FMA-2300) to monitor CO₂ flow. Commercially, CO₂ is normally recycled, but in the present setup, it was vented to a fume hood.

Samples were collected at different times and transferred to a 15 ml sample tube, which was flushed with nitrogen at 45 ° C to remove hexane by evaporation. Hexane flushing was done after collecting a sample (see Appendix A). Weight of oil was determined gravimetrically. The samples were collected after 15, 30, 45, 60, 90 and 120 minutes. The total extraction time was two hours for each SFE experimental run. Flow data was recorded with Labtech data acquisition software, which was further transferred to a spreadsheet to calculate the total amount of CO₂ used.

3.3.1. Determination of Diffusivity

Diffusivity was calculated using the analytical solution of Fick's law for spherical shaped particles (equation 2.5) truncated to 13 terms. The diffusivity value was regressed from the SFE kinetic data using the nonlinear regression technique Proc nlin (SAS Version 8).

3.4. Soxhlet Extraction

Soxhlet extractions were performed by the standard AOAC method (Aa- 4-38) using a Soxhlet apparatus (Kimax) and an electric heater (Electrothermal). 200 ml of solvent (Petroleum Ether) was filled in the flask, which was placed on the heater to change the solvent to a gaseous phase. The sample was filled in the thimble and placed in the middle portion (Butt tube) of the Soxhlet apparatus. The solvent was liquefied by cooling the solvent vapor by a water-cooled condenser. The flow rate of the cold water and temperature of the heater was adjusted to liquefy the solvent at the rate of 20 drops per minute to perform an extraction. After 4 hours, oil-laden solvent is transferred to a 15 ml tube.

3.5. Gravimetric Method

The samples were flushed with nitrogen in a heated water bath set to 45 ° C to remove hexane. The flow rate of N₂ was adjusted to 10 ml/min to complete the flushing step in approximately 45 minutes per batch of 24 samples. After flushing, the weight of the test tube containing oil was taken to determine the weight of oil. A similar procedure was applied to remove petroleum ether from the Soxhlet samples to calculate the weight of oil.

3.6. Gas Chromatography Analysis

Fatty acid analyses were accomplished by gas chromatography (Shimadzu GC- samples were analyzed using the external standard method. Some samples were also analyzed using internal standard method but all data reported in the results were analyzed by

the external standard method. Transmethylation of lipids was accomplished to produce fatty acid methyl esters (FAME) by the method suggested by W. W. Christie (26), which removes the fatty acids from the lipid glycerol unit during the methylation of the ester group.

Gas chromatography was done to determine the FAME content in the sample after transmethylation. Oil (glycerolipids) collected after extraction technique was diluted with hexane to make a concentration of oil in the range of 1-10 mg oil/ml of hexane. One ml of hexane was added to the oil extracted by SFE and 5 ml of hexane was added to the oil extracted by Soxhlet extraction. Chemicals used for the transmethylation step were hexane (1.9 ml), 1 M methyl acetate (20 μ L), 1M sodium methoxide (20 μ L) and acetic acid (30 μ L). The solution of sodium methoxide was made in methanol (see Appendix C). 20 μ L of nonadecanoic methyl ester (C19:0 FAME) was used as an internal standard. Solution of C19:0 FAME (10 mg/ml) was prepared by adding 40 mg of C19:0 FAME to 4 ml hexane. 100 μ L of the resulting solution was transferred to a 2.5 ml vial and was further diluted by adding 900 μ L of hexane. Transmethylation of the diluted oil was accomplished by adding 20 μ L of 1 M sodium methoxide and 20 μ L methyl acetate vortexed and allowed to react for 5 minutes. The solution became cloudy when sodium glycerol precipitates. The reaction was stopped by adding 30 μ L of 1M acetic acid. After transmethylation, fatty acid methyl ester analysis was completed by gas chromatography using the temperature program given in Table 3.1.

3.6.1. External Standard Method

Supelco 37 FAME mix was used for preparing a set of external standard mixtures. 3 mg of the mixture was added to 300 μ L of hexane to make the stock standard mixture (10mg/ml). The concentration of the individual fatty acid was determined by weight percent of the individual fatty acid given in the manufacturer list. The standard curve was constructed from standard mixtures (10mg/ml, 5mg/ml, and 3.33 mg/ml). Injection volumes were one μ L.

Table 3.1. Temperature program for fatty acid analysis

Initial Temperature (° C)	Final Temperature (° C)	Rate (° C/min)	Waiting time (minutes)
130	130	0	2
130	180	10	0
180	215	2	0
215	230	10	9

A calibration graph between area and concentration was plotted for each analyte to determine the slope (rate of change of area with respect to concentration). The response factors were determined by dividing the slope of each fatty acid standard curve by the slope of the internal standard. The concentration of the analyte was found using equation 3.1.

$$C = A/S \quad 3.1$$

Where C = concentration of analyte

A = area of an analyte from injection of the sample

S = slope of an analyte determined from the calibration graph

3.6.2. Effect of Dilution in Fatty Acid Analysis

Extracted oil was reacted with sodium methoxide and methyl acetate at 2 dilutions. In first dilution, extracted oil with an average weight of 0.1 g was dissolved in 1 ml of hexane. The second dilution was done by taking 100 μ L of the solution from first dilution (0.1 g in 1 ml) and adding 0.9 ml of hexane to it. The average concentration in the second dilution was 10 mg/ml. The transmethylation reaction at first dilution gave three different layers-top (transparent), middle (precipitate) and bottom (yellow pigment). GC analysis at this dilution gave inconsistent results. The precipitate may contain wax because rice bran oil contains appreciable amount of wax. Wax should be removed by winterization and filtration or centrifugation. The transmethylation reaction in the second dilution gave a relatively homogenous and clear solution with less precipitate.

CHAPTER 4

RESULTS AND DISCUSSION

4.1. Total Oil Analysis

4.1.1. Effect of Extraction Method

The type of extraction method affected the quality and yield of the oil. Figure 4.1 shows the samples of oil extracted by different extraction methods compared to a commercial sample of refined rice bran oil. Refined rice bran oil had less pigment compared to the oil extracted by SFE and Soxhlet extraction method. The SFE method yielded higher quality oil with less pigments than Soxhlet extraction, which yielded dark yellow colored oil. Extraction of colored pigments by Soxhlet extraction is also reported in the literature (27). The light color of the oil extracted by SFE is important for the processing of the oil because the dark color makes the bleaching process more difficult. In Soxhlet extraction most of the oil was extracted during the initial stages but total extraction time was four hours, where most of the oil was extracted. The SFE process removed about 51.5 % of the total ether extractable oil in 2 hours from the small particle size bran, which is comparable to the yield (51%) obtained by Fattori (13) for canola seed in 2 hours at 55 ° C, 36 MPa and 0.7 g/min flow rate of CO₂. The results obtained by Kim (28) showed the yield of 70 – 80 % for rice bran oil in 4 hours using supercritical CO₂. Similarly, the pilot scale supercritical CO₂ extractions conducted by Zhiping (6) showed the yield of 83 % for rice bran oil in 4 hours at 24.1 MPa and 40 ° C. Figure 4.2 shows a sample of big bioconverted bran before (left) and after (right) SFE. The sample before the extraction is darker compared to the sample after extraction. The change in the color may be due to the removal of oil. Appendix D shows the preliminary Soxhlet and SFE data.

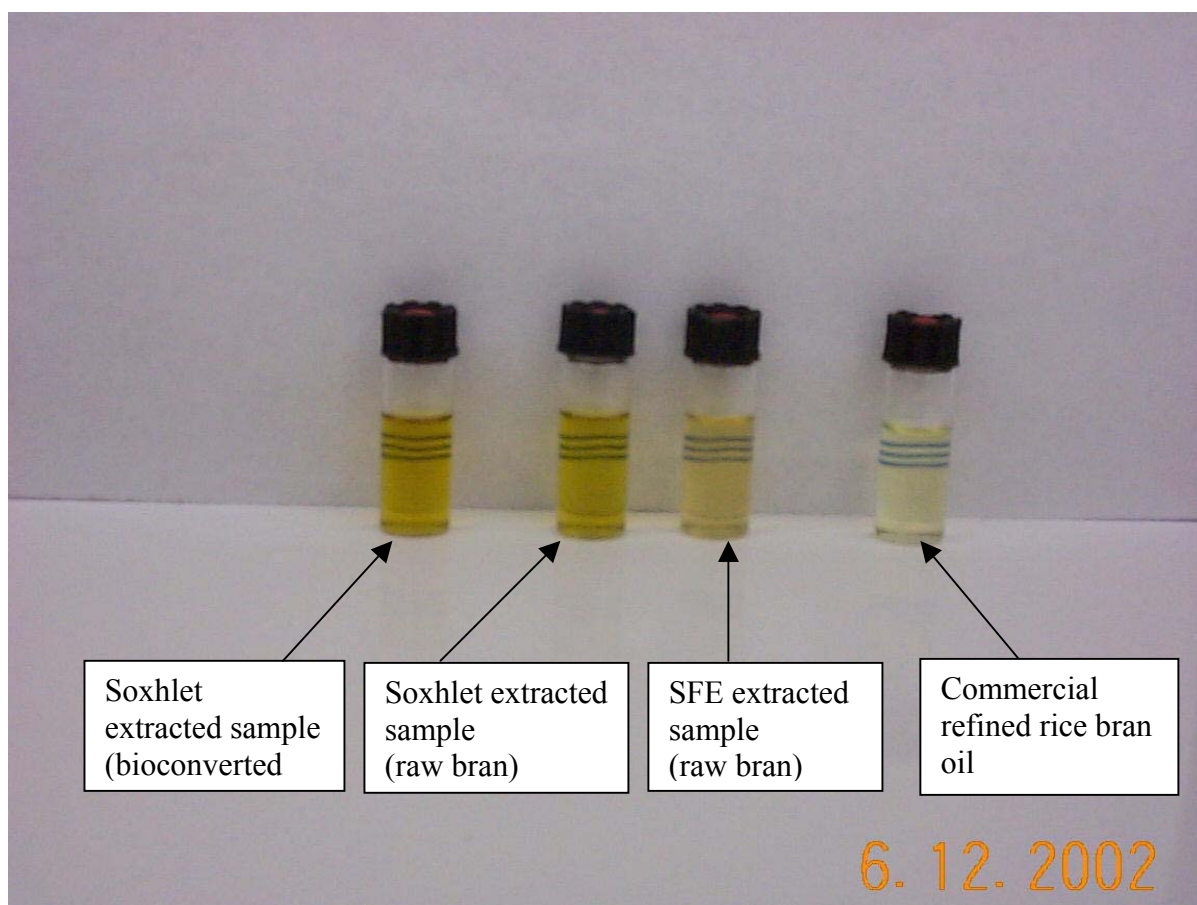

Figure 4.1 Samples of oil extracted by different extraction methods compared to commercial sample of refined rice bran oil



Figure 4.2. Samples of Big bioconverted bran before and after the SFE

4.1.1.1. Soxhlet Extraction

Oil yield from Soxhlet extraction exceeded 20 % of the total rice bran weight (Figure 4.3). One possible explanation for increased yield is the extraction of the ether soluble compounds other than oil. The oil yield was greater for bioconverted rice bran samples (28.05%) than oil yield for raw rice bran (22.366%). Statistical analysis shows that the weight of the oil is dependent on the biotreatment ($p=0.0017$).

4.1.1.2. Supercritical Fluid Extraction

Figure 4.4 shows the yield of oil by SFE. Small bran yielded 11.54 % oil, while big bran yielded 9.22 % oil. The yield for the small bioconverted bran and big bioconverted bran were 8.61 % and 7.48 % respectively. Figure 4.5 shows cumulative oil yield (g) at different CO₂ consumption. Small bran gave greatest oil yield, while big bioconverted bran gave the least oil yield for a particular CO₂ usage (50 g). Small bran gave larger yield than large bran and similarly, small bioconverted bran gave larger yield than big bioconverted bran. Statistically, oil yield was found to be dependent on treatment ($p = 0.0045$) and particle size ($p= 0.013$).

4.1.2. Effect of Biotreatment

Biotreatment of rice bran increased the yield of oil for Soxhlet extraction but showed a decrease in total oil yield by supercritical extraction. One possible explanation for decrease in the yield of fungal oil is the compact packing of the material after biotreatment. There was a change in the material surface after biotreatment and compaction of the material was observed, which may have caused channeling and decreased the mass transfer of oil. Channeling causes the solvent to flow in particular paths of bulk flow and decreases the solvent contact with the solute. This channeling factor should be considered during modeling. The use of glass beads or other packing material like saddles may decrease this problem.

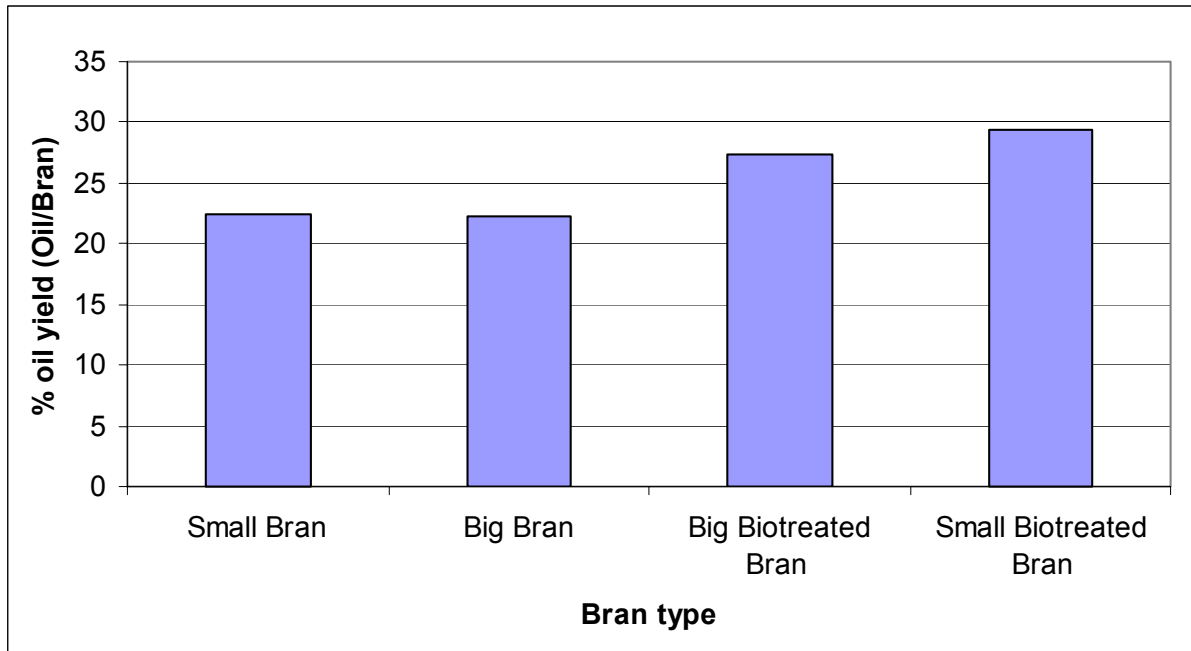

Figure 4.3. Oil yield (percentage) by Soxhlet extraction for raw and bioconverted rice bran

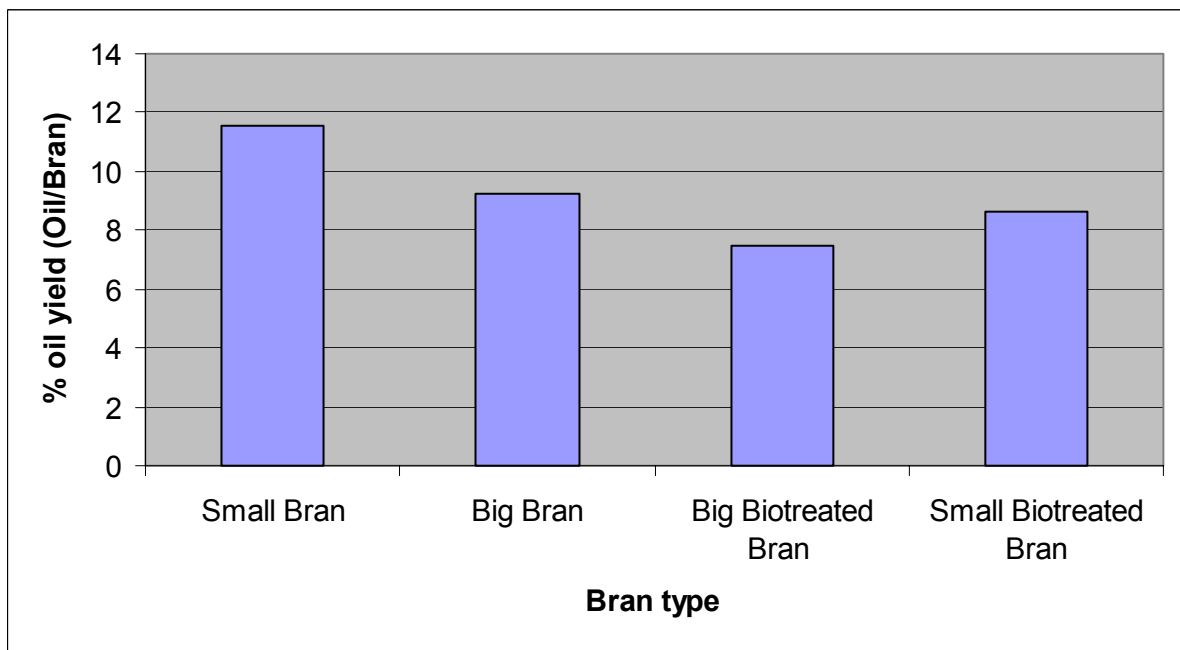

Figure 4.4. Oil yield (percentage) by SFE for raw and bioconverted rice bran

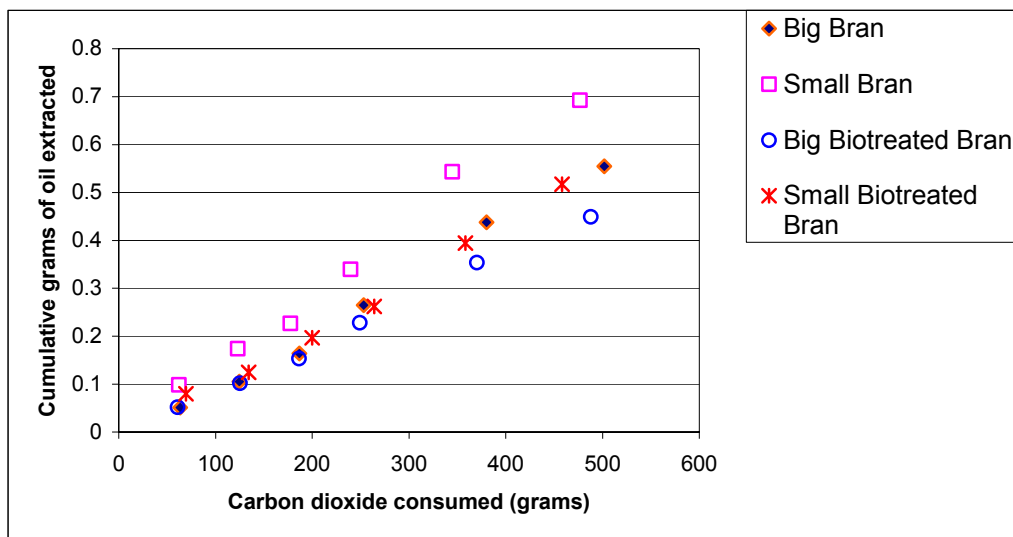

Figure 4.5. Cumulative oil yield per gram of CO₂ consumed for SFE

4.1.3. Effect of Particle Size

Figure 4.6 shows cumulative oil yield (g), illustrating the effect of particle size and biotreatment on the yield of oil at different times of extraction. The cumulative yield of the oil for the small bran was greater than big bran Figure 4.7 shows the specific cumulative oil yield (g per g carbon dioxide) illustrating the effect of particle size and biotreatment on the yield of oil. During the first 40 minutes of extraction, specific cumulative yield of small bran and small bioconverted bran decreased, while the specific cumulative yield for big bran and big bioconverted bran remained constant. Specific cumulative yield increased from 45 to 90 minutes. After 90 minutes of the extraction the specific cumulative yield decreased except for small bioconverted bran.

Differences in the yields may account for difference in mass transfer resistance, which was greater in the case of large particles as compared to small particles. One of the possible reasons for low oil yield in the large particles may be due to the structure of the particle where oil may have been trapped in large dead spaces. Differences in microscopic channel structure may result from differences in particle size, which may then affect the extraction rate. Fick's law states that the rate of diffusion is proportional to the concentration gradient (5). Rate of transfer of solute (oil) depends on convective mass transfer (bulk flow mass transfer) and diffusive mass transfer. At low flow rates, mass transfer is mainly due to diffusion and solubility predominates. The phenomena changes to the convective mass transfer with an increase in velocity (5). However, the process may be less efficient because more time is required at low flow rates but may be more effective if less carbon dioxide is consumed.

4.1.3.1. Diffusivity Measurement

Statistical models were used to calculate diffusivity with the data gathered at flow rate of 300 ml/min (Appendix E). The diffusivity of big bran ($2.53E-11$ m²/sec) was nearly

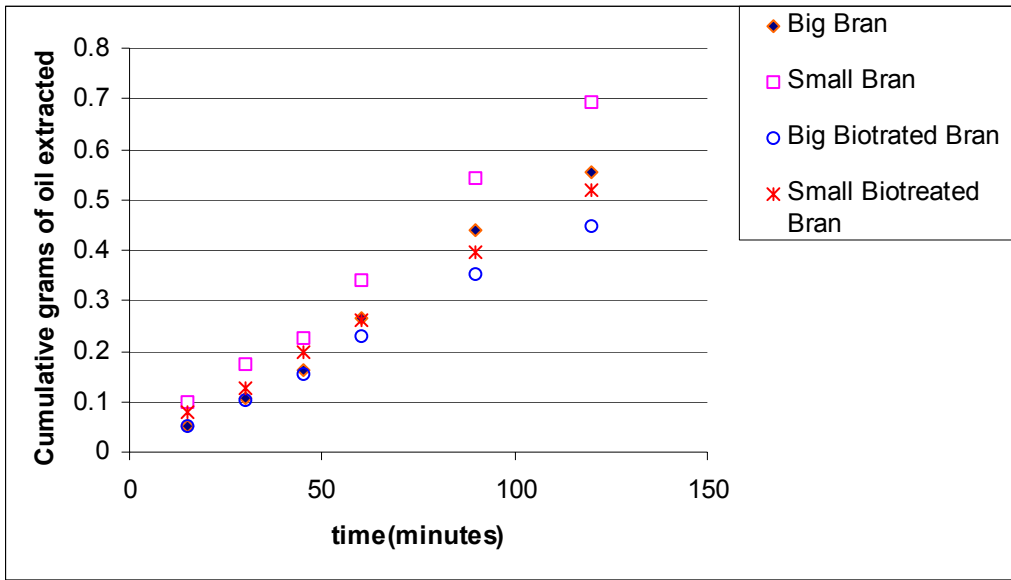

Figure 4.6. Cumulative oil yield at different time of extraction

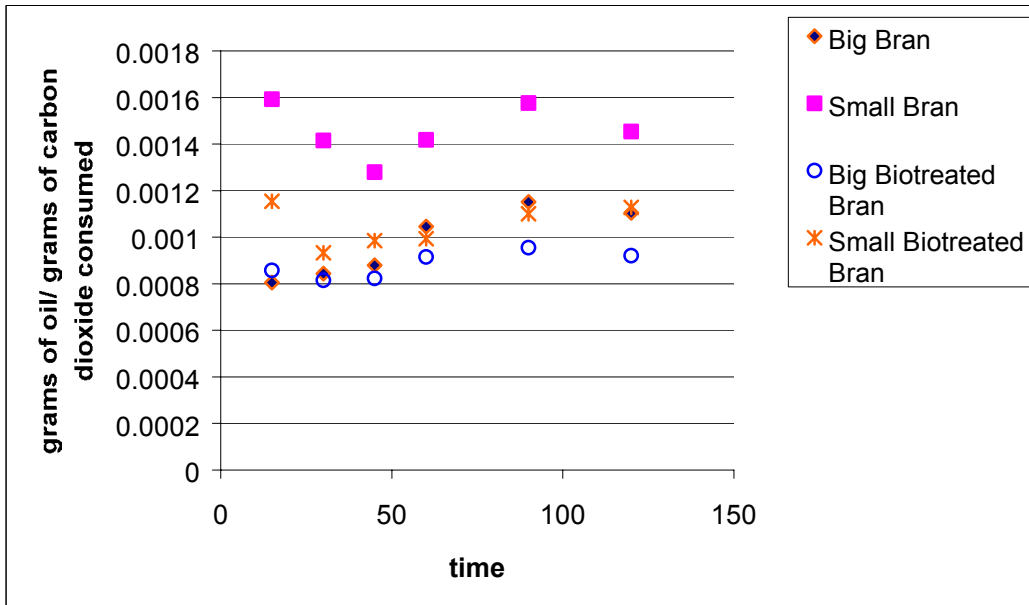

Figure 4.7. Cumulative oil yield per gram of carbon dioxide consumed at different time of extraction

twice that of small bran ($1.26\text{E-}11 \text{ m}^2/\text{sec}$) and similarly, the diffusivity of big bioconverted bran ($1.74 \text{ E-}11 \text{ m}^2/\text{sec}$) was nearly twice that of small bioconverted bran ($6.77\text{E-}12 \text{ m}^2/\text{sec}$). The diffusivity value reported from the literature at the same experimental conditions is $2 \text{ E-}13 \text{ m}^2/\text{sec}$ (29). The dependency of the diffusivity with particle size showed that concentration gradient was not a main driving force for the experimental data. Therefore, a better representation of mass transfer rate may result from determination of overall mass transfer coefficient, which represents convection mass transfer that predominated at earlier extraction time.

4.2. Fatty Acid Methyl Ester Analysis

The fatty acid methyl ester (FAME) analysis was accomplished by gas chromatography (GC). The GC results showed that rice bran oil contains myristic acid, palmitic acid, palmitoleic acid, stearic acid, oleic acid, and linoleic acid and α -linoleic acid. The percentage composition of fatty acids is shown in Table 4.1.1 for a typical rice bran sample for SFE and Soxhlet extraction. Results were compared with previous studies (15,21). Results of this study showed that SFE extracted slightly higher percentages of oleic acid, and slightly lower percentages of linoleic acid. The results of this study were similar to those of Saito et al. (14), which showed that SFE extracted more oleic acid and myristic acid, but less linoleic acid when compared to the Soxhlet extraction. This might be explained by the ability of SFE to extract lower molecular weight compounds due to higher solubility of these compounds at the given conditions. More than 90 % of the fatty acid composition in the rice bran was composed of palmitic acid (16%), oleic acid (46.6 %) and linoleic acid (32%). Table 4.1.2 shows the composition of fungal oil produced by the growth of *Pythium irregulare* on rice bran media for a typical sample, which was compared with the fatty acid distribution in *Pythium irregulare* grown on 2% glucose

Table 4.1.1. Composition (weight %) of rice bran oil

Fatty acid	Composition (Soxhlet) 4 hr	Composition (SFE) 2 hr	Reference (15)	Reference (21)
Mystric acid	0.35	0.56	-	1.7
Palmitic acid	15.97	18.59	20.7	19.6
Palmitoleic acid	0.18	0.23	-	-
Stearic acid	2.14	1.96	2.9	0.7
Oleic acid	46.69	48.32	45.2	42.3
Linoleic acid	32.09	28.38	30.4	31.3
α - Linolenic acid	1.31	1.04	0.8	2.3
Others	1.20	0.90	-	-

Table 4.1.2. Average composition (FAME weight %) of bioconverted samples compared with pure *P. irregularis* cultures grown on glucose media (29).

Fatty acid	Composition (Soxhlet)	Composition (SFE)	Reference (29)
Mystric acid	0.89	1.17	16.8
Palmitic acid	13.38	15.34	18.6
Palmitoleic acid	0.28	1.37	4.1
Stearic acid	2.00	1.81	1.1
Oleic acid	46.07	47.60	17.3
Linoleic acid	31.10	28.13	16.0
α - Linolenic acid	1.23	0.97	-
γ Linolenic acid	0.77	0.54	1.2
AA	0.99	0.67	8.2
EPA	1.65	1.81	10.5
Others	0.32	1.13	3.8

medium (27). Biotreatment produces important fatty acids like AA, γ -linolenic acid, h- γ -linolenic and EPA.

4.2.1. Soxhlet Method

4.2.1.1. Effect of Biotreatment

Percentage of mystric acid increased with the biotreatment from 0.354 % to 0.85% ($p < 0.0001$) while the percent composition of palmitic decreased from 15.97 % to 13.38 % ($p = 0.0001$). Small bioconverted bran (31.19%) and big bioconverted bran (31.02%) have relatively less linoleic acid than raw rice bran ($p < 0.001$).

4.2.1.2. Effect of Particle Size

Particle size had no effect on mystric acid percent composition. Results show that big bran (47.02%) contained a greater percentage of oleic acid compared to small bran (46.35%) with $p = 0.0758$, while small bioconverted bran contain the higher percentage of oleic acid than big bioconverted bran without any statistical significance. Small bran (32.504) contain more linoleic acid than the big bran (31.67) with a $p < 0.0001$. Soxhlet extraction yielded 0.823 % and 0.72 % of γ -Linolenic acid from big bioconverted bran and small bioconverted bran respectively ($p = 0.0001$). The percentage of EPA in big bioconverted bran was 1.119% and in small bioconverted bran was 0.87% with $p = 0.0001$. Similarly, AA was more in big bioconverted bran (0.35%) than small bioconverted bran (0.29%) with a $p = 0.0049$.

4.2.2. Supercritical Fluid Extraction

4.2.2.1. Effect of Time

The Statistics indicated that fatty acid concentration did not changed significantly with time i.e. the fractionation of the fatty acid was not proved. The large standard deviation in the result was one of the main reasons for not seeing the fractionation statistically.

Figure 4.8 shows the yield of EPA and AA at different times of extraction. Big bioconverted bran yielded more AA than small bioconverted bran by supercritical extraction

after 2 hours. There was no specific trend found in the suppressed production of the EPA with the elevated production of AA. The AA in small bioconverted bran was extracted primarily at the later stages of the extraction i.e after 45 minutes of the extraction, while the extraction of AA in big bioconverted bran fluctuated with time. No specific trend was found for extraction of EPA.

Figures 4.9.a and 4.9.b show the fatty acid distribution for the first 15 minutes of extraction in big bran, small bran, big bioconverted bran and small bioconverted bran. Big bioconverted bran (1.60%) contained a larger percentage of EPA than small bioconverted bran (0.63%) where $p = 0.0296$. Similarly, the percentage of AA was large in big bioconverted bran (0.926%) compared to small bioconverted bran (0.08%) with a $p = 0.002$.

Small bioconverted bran (53%) showed more oleic acid than big bran (48.67%), small bran (47.356%), and big bioconverted bran (45.97%), but statistical differences were not significant. Small bioconverted bran (18%) contained a low percentage of linoleic acid.

4.2.2.2 Effect of Biotreatment

Results showed that the biotreatment had a significant effect on percent composition of mystric acid ($p < 0.0001$). The initial concentration of mystric acid was found to be in the range of 0.44 % - 0.67 % and it increased to 1.07 % - 1.37 %. There were no other significant effects observed for the change of fatty acid composition due to the biotreatment with the exception of the production of AA and EPA because of their natural occurrence in the fungal biomass only.

4.2.2.3. Effect of Particle Size

Small bioconverted bran had a greater percentage of palmitic acid ($p < 0.0001$) and oleic acid ($p = 0.025$), but a smaller percentage of linoleic acid ($p = 0.007$), γ -linolenic acid ($p < 0.001$), α -linolenic acid ($p = 0.0007$) and AA ($p < 0.0001$) than big bioconverted bran. EPA concentration in big bioconverted bran and small bioconverted bran were 1.86% and 1.78%

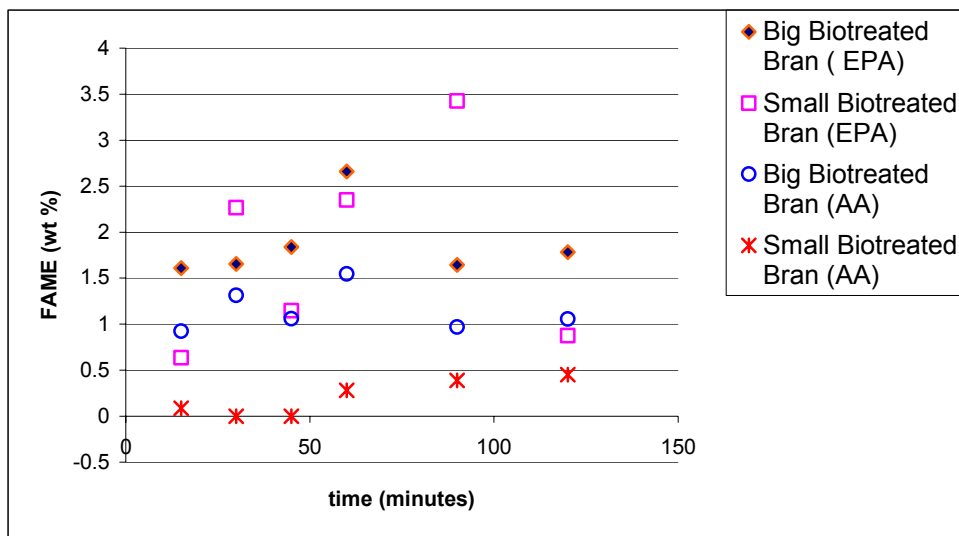
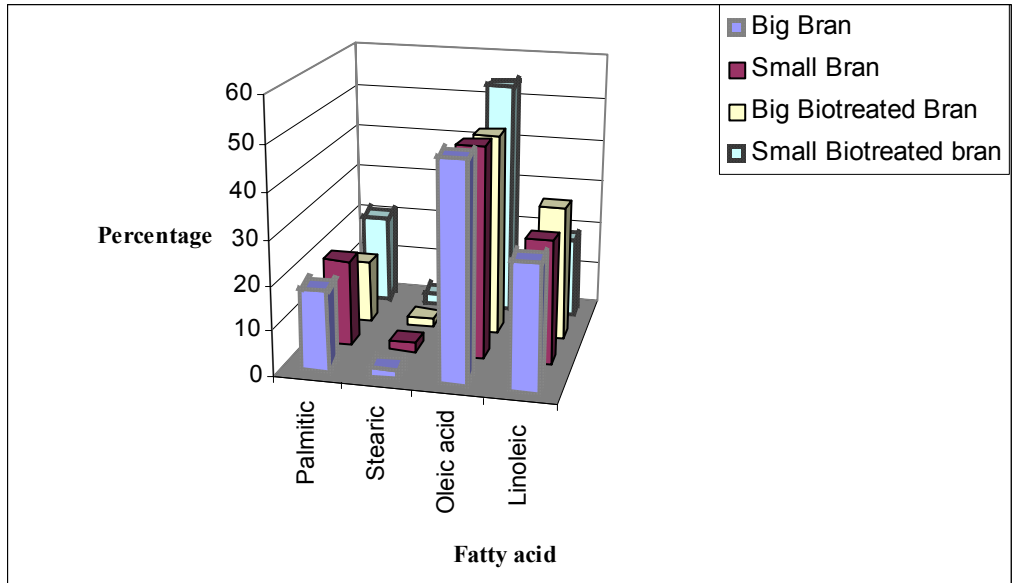
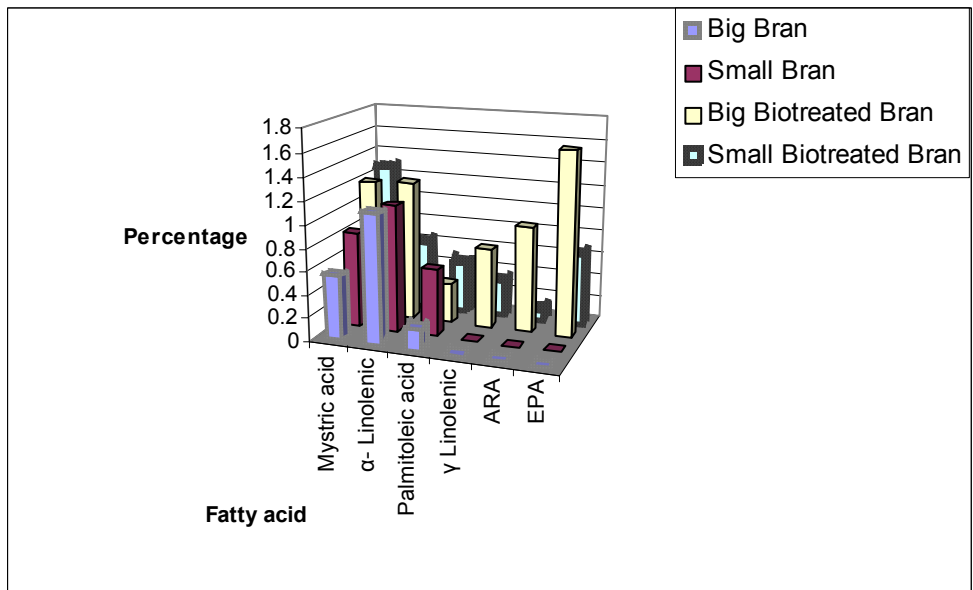

Figure 4.8. Yield of EPA and AA at different times of extraction for bioconverted samples of big and small particle sizes.

respectively. The concentration of palmitic acid in the rice bran oil increased from 17 % to 18.8 % with the decrease in the particle size ($p = 0.004$).



a.



b.

Figure 4.9. Fatty acid distribution after 15 minutes of SFE
 a. Major components b. Minor components

CHAPTER 5

CONCLUSIONS AND RECOMMENDATIONS

5.1. Conclusions

Rice bran is a byproduct of rice industry that is rich in vitamins, minerals, amino acids, essential fatty acids and antioxidant nutrients. It has an impressive nutritional quality suitable for nutraceutical production. Rice bran is often discarded because of the rancidity created by the hydrolysis of oil. Present experiments were directed towards finding an engineering solution for increasing the value to the rice bran by the potential utilization of the by-product material by fermentation to produce product of high value. Study was focused on determining the effect of particle size (<48 mesh and 16-48 mesh) and biotreatment on the yield and quality of rice bran oil. Biotreatment was accomplished by growing *Pythium irregulare* on rice bran media.

Results showed the feasibility of extracting oil from rice and bioconverted rice bran by SFE technique. SFE yields, in general, increased with a decrease in particle size for the rice bran and bioconverted bran and extracted oil with fewer pigments. Effect of biotreatment under Soxhlet extraction and SFE was also studied. The effect of the extraction technique was significant because of the difference in the extraction time (SFE - 2 hours, Soxhlet -4 hours).

Rice bran oil has industry potential in cosmetic and food industry. Furthermore, biotreatment produces important fatty acids like AA, γ -linolenic acid, and EPA that are of nutraceutical value. Therefore, biotreatment makes rice bran oil more suitable for nutraceutical purposes but one of the challenges lies in designing the packing technique for reducing the problem of channeling.

As expected the results showed the increase in the yield with the decrease in the particle size for SFE and Soxhlet. Biotreatment decreases the yield with SFE. Soxhlet extraction showed the dependence of the weight of oil on biotreatment ($p= 0.0017$) but not on the particle size, while SFE showed the dependence of the weight of oil on biotreatment ($p = 0.0045$) and particle size ($p= 0.013$). The dependence of performance of SFE on particle size is of practical significance due to mass transfer resistance.

Some of the challenges involved in SFE are

- Designing the packing technique for reducing the problem of channeling
- Operating the process at high pressure (Safety issues)
- Controlling the flow rate of oil laden CO₂ at sample collection point.

5.2. Recommendations

The study of metabolism pathway during the biotreatment process can be an important area. Desaturase metabolism can be one of the possible pathways. The GC result shows that fatty acids formed during the Desaturase metabolism are found in fungal rice bran oil. There is a possibility of usage of Linoleic acid, present in the raw rice bran for the production of AA, γ Linolenic acid and C20: 3. The effect of the particle size on the yield of AA and EPA can be a specific point of research. It seems that AA and the intermediate products formed in the path1 of the desaturase metabolism are more in the oil extracted from the large particle size than the small particle size. In the present study, rice bran is separated into two particle size after the biotreatment (Figure 5.1) Biotreatment of big bran and small bran should be done separately to study the effect of particle size on the metabolic activity (Figure 5.2).

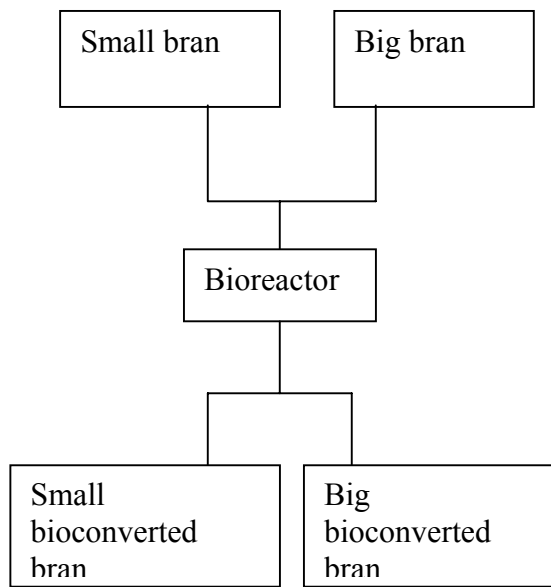

Figure 5.1 Present experiment plan

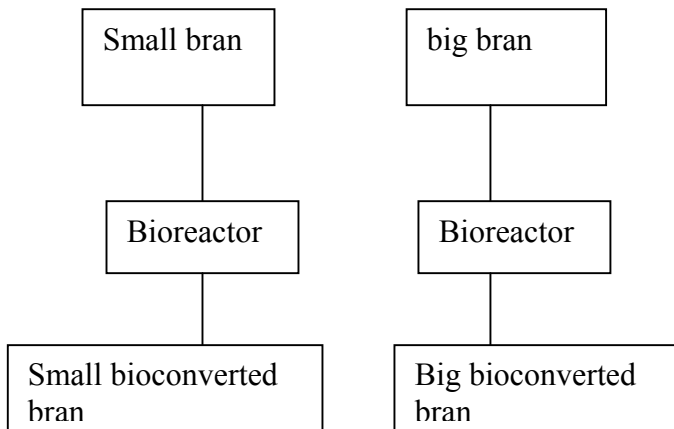

Figure 5.2 Proposed experimental plan

REFERENCES

- 1) Cheruvanky, R. What is Rice Bran (a web article on rice bran)
<http://www.moormans.com/equine/TechBulletins/WhatIsRiceBran.htm> (2002)
- 2) The American Heritage® Dictionary of the English Language, Fourth Edition,
www.dictionary.com(2000).
- 3) Official web site of USDA
<http://www.ars.usda.gov/is/AR/archive/aug01/fluid0801.htm> (2002).
- 4) Sayre, R.N., R.M. Saunders, Extraction and refining of edible oil extrusion stabilized rice bran. *J. Oil Chem. Soc.* 62: 1040-1043 (1985).
- 5) Treybal, R.E., Mass-Transfer Edition, Third Edition, McGraw-Hill (1981).
- 6) Shen, Z., M.V.Palmer, S.S.T.Ting and R.J.Faiclough. Pilot scale extraction and fractionation of rice bran oil using Supercritical carbon dioxide, *Agric. Food Chemistry*, 45:4540-4544(1997).
- 7) Xu, Z. and J.S. Godber, Comparison of supercritical fluid and solvent extraction methods in extracting gamma-oryzanol from rice bran, *J. Am. Oil Chem. Soc.*, 77: 547-551(2000).
- 8) Hulbert, G.J., M.H. Cheng, T.H. Walker, D.R.Raman, Fungal production of eicosapentaenoic and arachidonic acids from industrial waste streams and crude soybean oil, *Biores. Tech* 67:101-110(1999).
- 9) Kiran, E., P.G. Debenedetti and C.J. Peters, Supercritical Fluids- Fundamentals and Applications, Kluwer Academic Publications, Boston (1998).
- 10) Prausnitz, J.M., R.N. Lichtenthaler and E.G Azevedo, Molecular thermodynamics of fluid phase equilibria, Second Edition, Prentice- hall (1986).
- 11) Rizvi, S.S.H., Supercritical fluid processing of food and biomaterials, Blackie academic and professional, New York (1998).
- 12) A. Awasthi and R.K. Trivedi, A review on supercritical carbon dioxide extraction of natural products, *Chemical Engineering world Feature/article* (1997).
- 13) Fattori, M. and A. Meisen, Carbon Dioxide Extraction of Canola Seed: Oil Solubility and Effect of Seed Treatment, *J. Oil Chem. Soc.* 65:968-974(1988).
- 14) Saito, Y.Ikushima, K.Hatakeda, S.Ito and T.Goto, Fractional extraction of rice bran oil and its esters with supercritical carbon dioxide *Int. Chem.Eng.* 33:307 – 314(1993).

- 15) Sarkar, S., Nutrition of Rice Bran Oil in Relation to its Purification, *Am. Oil Chem. Soc.* 68:956-962 (1992).
- 16) Pandian, S.S., Fatty acids and prostate cancer: current status and future challenges. *J. Roy. Coll. Surg. Edinb.* 44:352-361(1999).
- 17) Dunford, N.T., J.W. King, Thermal gradient deacidification of crude rice bran oil utilizing supercritical carbon dioxide, *J. Am. Oil Chem. Soc.* v 78, n 2, p 121-125 (2001).
- 18) Radwan, S.S, Sources of C20 – Polyunsaturated fatty acids for biotechnological use, *Appl. Microbial. Tech.* 35:421-430(1991).
- 19) Shimizu, S., Microbial Conversion of an oil containing α Linoleic acid to an oil containing Eicosapentanoic acid, *J. Am. Chem. Oil Soc.* 66:342-347 (1989).
- 20) Andriya, M., J. B. Gray, Essential Fatty Acid Metabolites in the Pathogenesis and Management of the Chronic Fatigue Syndrome, *J. CFIDS. Assoc. Amer.* 1994; 18-28, (<http://homepages.ihug.com.au/~dieteasy/cfids.htm>).
- 21) Narisullah, M.N Krishnamurthy, Effect of stabilization on the Quality Characteristics of Rice Bran oil, *J. Am. Chem. Oil Soc.* 66: 661-663 (1989).
- 22) Johnson,G.,M. Salassi, Rice outlook 24-26 (2002).
- 23) Reverchon, E. and A. Kaziniunas, Mathematical Modeling of Supercritical Extraction of Sage Oil, *Am. Inst. Chem. Eng. J.* 2:1765 -1771 (1996).
- 24) Crank, J. (1975). *The Mathematics of Diffusion*. Oxford University Press Inc., New York, second edition.
- 25) Walker,T.H., C.Drapcho, and H, Zhu, Bioconversion of rice bran to ω -3 fatty acids by *Pythium irregulare* fermentation, *Am. Soc. Ag. Eng.* (2001).
- 26) Christie, W.W., Preparation of fatty acid methyl ester. *J.Lipid.Res.* (1982).
- 27) Kuk, M.S., M.K. Dowd, Supercritical CO₂ extraction of rice bran, *J. Am. Oil Chem. Soc.*, v 75, n 5, May, 1998, p 623-628.
- 28) Kim, H.J, H.I., Kwon, Characterization of extraction and separation of rice bran oil rich in EFA using SFE process, *Separation and Purification Technology*, v 15, n 1, Jan 4, 1999, p 1-8
- 29) Walker T.H., H.D. Cochran and G.J. Hulbert, SFE of lipids from *Pythium irregulare*, *J Oil Chem. Soc.*,76:596-602(1999).

APPENDIX A
OPERATING GUIDELINE FOR SFE

High Pressure Flushing: an engineering solution to the problem of clogging in SFE.

Preventive maintenance is the best technique for performing the operations in a smooth manner. SFE is a unit operation that demands for efficient process control. Apart from process control, there are certain problems, which require an efficient engineering solution. One of the problems is clogging which is caused by extraction material like rice bran or packing material like glass wool. Clogging can be controlled by incorporation of high pressure flushing in the design of extraction unit. It should be performed after every run to ensure the clean pipelines and valves for the next run.

High pressure (H.P) flushing is demonstrated in the design of SFE unit set up at department of Biological and Agricultural Engineering, LSU. Six Valves are used at different locations for separating the various subunits in the system (Figure 3.2). H.P flushing is incorporated by the tubing which connects Valve D and Valve B. It could regulate the flow of high pressure CO₂ in the direction B-D-E-F. CO₂ can flow through Sample collection without flowing through extraction cell. The existing setup can release pressure from any part of the unit without affecting other subunits.

Operation Guidelines

SFE operates under extreme conditions. The following guidelines will not only increase the safety but will also decrease the learning time for an operator.

- Isolate hexane tank from CO₂ by closing valve D while doing extraction
- Prevent explosion at sample collection unit before starting extraction by partially opening the valve F.
- Valve should be operated on the basis of top to bottom rule after hexane flushing and before doing subsequent extraction.

- Top to bottom Rule defines the order of operating the valves in a particular pattern. Partially close the valve F, Fully close the Top E Valve and finally open Bottom E Valve. The operation of the valve in the following way will prevent the explosion and is safe.
- Hexane flushing should be done with the time as the sample is collected after regular interval. It should be done in following manner –
 - Close the Bottom E valve for cutting the CO₂ Flow to the sample collection unit
 - After one minute, slightly open the valve F so that CO₂ can escape fast .
 - Before doing Hexane Flushing, Make sure that there is no CO₂ between Valve F and E by checking the flow rate of CO₂ by flow meter and if there is any gas than vent it through Sample collection unit or Valve F .
 - Perform the hexane flushing .
- After completing a experiment, Cut the pump from rest of the unit by closing valve B and than open Safety release valve i.e. valve A for releasing any gas in the line. Extraction Cell should be taken out of the unit after releasing the gas
- Clogging can be eliminated by flushing the pipelines of the unit by high-pressure gas after every extraction. It is like the practice of preventive maintenance. It should be done in the following manner .
 - Close Valve C and open Valve D for flushing the sample collection unit area where rice bran and glass wool can cause clogging
 - Close Valve D and open valve C for flushing rest of the unit

APPENDIX B

STANDARD OPERATING PROCEDURE FOR GAS CHROMATOGRAPHY

OBJECTIVE

The objective is to maintain a standard procedure in a documented form for operating a Gas Chromatography (GC) machine and to provide uniform and clear instructions.

SCOPE AND RESPONSIBILITY

It is the responsibility of the student to read and follow the SOP instructions. A supervisor should make sure that the instructions are being followed. The student should refer to the checklist (attachment # 1) while operating the GC machine. The student should document and inform any operational problem to the supervisor. The supervisor should document and implement a resolution and a corrective action of the problem. It is the responsibility of the supervisor to inform the concerned authority about the progress of the project.

PROCEDURE

- a. Check the pressure of the gas cylinders by reading the pressure gauge mounted on the gas cylinder. The cylinder must be replaced if the pressure reading is less than 700 psi.

NOTE: *Keep gas cylinders fastened by a chain*

- b. Turn the valves of the gas cylinders.

NOTE: *The valve of the gas cylinder should be fully open during an experimental run. A Semi-open valve can cause the cylinder to blow*

- c. Adjust the system pressure to the specified value (Air = 50 kPa, Hydrogen = 60 kPa and Helium = 80 kPa) by turning the knobs located on the GC machine.
- d. Check the electrical connections of the GC by inspecting all electrical plugs.
- e. Press the start button on the GC machine pad to start the GC machine.
- f. Press the ignite button on the GC machine pad to ignite the detector (FID).

- g. Click the Shimdazu GC-17 icon on the desktop of the personal computer to get the selection screen.
- h. Click the GC-17 AV3 tab on the selection screen to get the GC -17A screen.
- i. Click the method icon on the tool bar of the GC -17A screen.
- j. Click the GC-17A setup option to get the method screen.
- k. Check the communication between the GC machine and GC software by pressing the download tab on the method screen. The machine will get locked if the GC machine and GC software are communicating with each other. Press the lock key followed by the enter key on the GC machine pad to unlock the system. Students should fill the form 101(attachment # 2) if there is a problem in the communication.
- l. Click the OK tab on the method screen to get the GC-17A screen.
- m. Click the run icon on the tool bar of the GC-17A screen to get the run screen.
- n. Select a method file by clicking the method icon on the run screen. A supervisor must approve the method file selected for a particular analysis. A method file stores important analysis variables that should not be changed without approval from the supervisor .
- o. Select an output data file by clicking the output icon on the run screen.
- p. Document the names and locations of the method file and the output file.
- q. Fill sample in the 2.5 ml vial and hexane in the 4 ml vial provided by the vendor.
- r. Place the sample vial in the sample port and the hexane vial in the solvent port.
- s. Press the start button on the GC-17A screen to start the analysis and wait for the analysis to be complete.
- t. Press the system tab followed by the stop tab on the GC machine pad after completing all experimental runs.

Note: *Any problem encountered during the analysis should be documented by filling form 101(attachment # 2).*

- u. Close the valves of the hydrogen cylinder and the air cylinder to full close position and leave the valve of the helium cylinder to full open position after completing all experimental runs.

Note: *Do not close the valve of helium cylinder.
Close the valves of the hydrogen cylinder and the air cylinder*

PREPARED BY

Rohit Badal (Student)
06/02/02

APPROVED BY

Terry (Supervisor)
06/05/02

Attachment # 1

Checklist

Before starting the GC analysis

- Have you checked the electrical connections of the GC by inspecting all electrical plugs?
- Have you checked the communication between the GC software and the GC machine?
- Are the gas cylinders (Hydrogen, Helium and Air) fastened by a chain?
- Have you checked the pressure in the gas cylinders?
- Are the valves of the gas tanks fully open?

After completing the GC analysis

- Are the valves of the hydrogen cylinder and the air cylinder fully closed?
- Is the valve of the helium cylinder fully open?
- Have you set off the GC system after completing all experimental runs?

Attachment # 2

Form 101

Problem

The GC machine and the GC software were not communicating. Electrical plugs were inspected to check the electrical connections of the GC. The pressure in the gas cylinders was checked.

Reported by

Rohit Badal
06/15/02

RESOLUTION

Student XYZ installed the Stella (design software) on the personal computer used for GC analysis. Stella was interfering with the GC software.

Prepared by

Terry
06/17/02

CORRECTIVE ACTION

Uninstall the Stella software. In future, students must take a written permission from their supervisor before installing the software program on any personal computer that is used in the processing lab.

Prepared by

Terry
06/18/02

APPENDIX C
CALCULATIONS

C.1. Preparation of Sodium Methoxide for FAME analysis

1 molar sodium methoxide is prepared from 25 weight % solution. Following calculation was done for preparing the solution

Given:

Weight percent of Sodium Methoxide solution = 25 % (One gm of solute in 4 g of solution)

Ratio of Solute to solvent = 1/3

Density of Sodium Methoxide solution = .945

Molecular wt of Na = 54.5

Density of Methanol = .796 gm/cc or 796 g /liter

Desired:

Molarity of solution = 1M i.e. 54.5 g of solute per 796 g of solvent

Ratio of solute/solvent = $54.5/796 = 1/14.6$

Current Sodium Methoxide solution has solute /solvent = 1/3

Weight of 4 ml of given Sodium Methoxide (25 weight %) solution = 3.78 gm

Solute (Sodium Methoxide) in the current solution = $3.78/4 = .945$ g

Weight of solvent required for making 1 M solution = $.945 * 14.6 = 13.797$ g

Volume of Methanol required (already added) = $13.797 \text{ g} / .796 \text{ g/cc} = 17.322$ ml

Initial volume of Methanol in the solution = $2.835 \text{ g} / .796 = 3.561$ ml.

Total volume of Methanol = 20.883 ml

X ml of Sodium Methoxide to be added to adjust molarity to 1M =

$(.945 + (X/4)*.945) / ((20.883*.796 + (X*3/4)*.945) = 1/14.6$

Solving the above equation gives x = .1999 ml

So 0.1999 ml of Sodium Methoxide solution has to be added.

C.2. Radius of rice bran from the sieve used for separating rice bran in two sizes

Mesh - the number of opening per inch of a screen

Particles with two mesh size were used –

Big particle - 16 – 48 mesh

Small particle - >48 mesh

Average mesh size for big particle = 32 mesh

i.e. 1 inch will have 32 opening or each opening will have a length of 1/32 inch

So radius of sphere is $1/64$ inch = $2.54/64 = 0.39$ mm

Average mesh size for small particle = 60 mesh

Radius of sphere = $1/120$ inch = 0.2116 mm

APPENDIX D
PRELIMINARY SFE AND SOXHLET DATA

Table 6.1.1. FAME and gravimetric data for SFE where PS is particle size (5- Big particle size, 6- small particle size), TRT is treatment (3- no treatment, 4 –biotreatment), C16:1 is palmitoelic acid and Lin is Linoleic acid.

Time (min)	PS	TRT	weight (gms)	Mystric	Palmitic	C16:1	Stearic	Oleic	Linoleic	γ Lin	α- Lin	h-γ Lin	ARA	EPA
15	5	3	0.05	0.59	19.35	0.00	2.28	50.90	25.32	0.00	0.95	0.00	0.00	0.00
30	5	3	0.05	0.53	18.36	0.00	2.27	50.00	26.48	0.00	0.95	0.00	0.00	0.00
45	5	3	0.03	0.52	19.74	0.00	2.38	53.89	22.14	0.00	0.64	0.00	0.00	0.00
60	5	3	0.15	0.52	18.13	0.00	2.27	50.02	26.43	0.00	0.99	0.00	0.00	0.00
90	5	3	0.20	0.00	18.74	0.00	1.69	45.59	32.91	0.00	1.06	0.00	0.00	0.00
120	5	3	0.07	0.41	16.95	0.22	1.95	45.65	32.42	0.00	1.38	0.00	0.00	0.00
15	5	3	0.06	0.55	17.10	0.36	2.08	46.46	31.07	0.00	1.32	0.00	0.00	0.00
30	5	3	0.05	0.55	17.46	0.00	1.92	46.23	31.47	0.00	1.37	0.00	0.00	0.00
45	5	3	0.09	0.42	15.45	0.30	1.80	41.92	37.98	0.00	1.29	0.00	0.00	0.00
60	5	3	0.05	0.44	16.78	0.31	1.93	45.33	32.90	0.00	1.40	0.00	0.00	0.00
90	5	3	0.14	0.43	16.76	0.22	1.92	45.31	32.99	0.00	1.39	0.00	0.00	0.00
120	5	3	0.16	0.39	16.70	0.22	1.96	45.45	32.92	0.00	1.39	0.00	0.00	0.00
15	6	3	0.11	1.13	22.90	0.85	1.97	48.89	23.34	0.00	0.91	0.00	0.00	0.00
30	6	3	0.08	0.85	19.94	0.00	1.82	46.96	28.78	0.00	1.17	0.00	0.00	0.00
45	6	3	0.01	0.48	16.72	0.34	1.86	45.62	32.71	0.00	1.34	0.00	0.00	0.00
60	6	3	0.15	0.00	17.44	0.00	0.00	48.74	33.81	0.00	0.00	0.00	0.00	0.00
90	6	3	0.24	0.46	16.64	0.36	1.92	45.65	32.51	0.00	1.34	0.00	0.00	0.00
120	6	3	0.13	0.50	17.44	0.35	1.84	45.68	31.91	0.00	1.30	0.00	0.00	0.00
15	6	3	0.09	0.54	16.35	0.32	1.95	45.82	32.62	0.00	1.30	0.00	0.00	0.00
30	6	3	0.07	0.90	20.90	0.23	2.44	55.66	17.96	0.00	0.58	0.00	0.00	0.00
45	6	3	0.10	1.28	26.18	0.43	2.64	59.35	8.95	0.00	0.13	0.00	0.00	0.00
60	6	3	0.07	1.09	25.62	0.66	2.49	58.64	9.61	0.00	0.11	0.00	0.00	0.00
90	6	3	0.17	0.37	16.21	0.20	1.89	45.45	33.49	0.00	1.36	0.00	0.00	0.00
120	6	3	0.17	0.55	18.35	0.12	1.87	46.47	30.44	0.00	1.22	0.00	0.00	0.00
15	5	4	0.04	1.21	14.06	0.35	1.88	45.30	31.54	0.73	1.27	0.22	0.93	1.61
30	5	4	0.08	0.12	13.73	0.35	1.81	45.20	32.42	0.81	1.32	0.33	1.09	1.82
45	5	4	0.03	1.16	13.72	0.37	1.75	44.61	32.25	0.83	1.32	0.30	1.06	1.76
60	5	4	0.06	1.13	13.58	0.35	1.77	44.57	32.10	0.83	1.30	0.46	1.06	1.80
90	5	4	0.13	1.27	13.89	0.42	1.77	44.52	32.23	0.80	1.33	0.23	1.03	1.74
120	5	4	0.10	0.96	13.38	0.30	1.89	45.56	31.65	0.82	1.28	0.34	1.05	1.76
15	5	4	0.07	1.20	14.38	0.35	1.96	46.65	29.57	0.67	1.19	0.21	0.93	1.61
30	5	4	0.02	1.35	14.13	0.38	1.74	45.18	31.26	0.77	1.26	0.00	1.53	1.49
45	5	4	0.08	1.17	13.62	0.37	1.74	44.78	32.22	0.82	1.32	0.00	1.06	1.92
60	5	4	0.09	1.10	13.36	0.34	1.75	43.86	30.95	0.78	1.27	0.00	2.03	3.52
90	5	4	0.12	1.11	13.72	0.33	1.77	44.92	32.23	0.88	1.31	0.31	0.91	1.55
120	5	4	0.09	1.07	13.71	0.33	1.78	44.78	31.95	0.85	1.30	0.32	1.06	1.81
15	6	4	0.05	1.19	18.01	0.46	2.19	51.85	22.42	0.44	0.83	0.00	0.00	0.87
30	6	4	0.04	1.62	23.12	0.70	2.27	54.71	15.03	0.00	0.42	0.00	0.00	0.37
45	6	4	0.07	1.31	17.68	0.50	1.98	50.31	24.88	0.59	0.99	0.00	0.00	1.10
60	6	4	0.07	1.35	17.97	0.48	1.89	49.58	24.24	0.55	0.94	0.12	0.57	1.00
90	6	4	0.13	0.68	18.33	0.00	2.19	48.72	23.78	0.00	0.00	0.00	0.00	5.47
120	6	4	0.12	1.44	15.87	0.41	1.61	44.82	30.56	0.83	1.24	0.23	0.80	1.35
15	6	4	0.11	1.37	22.61	0.43	2.34	55.87	14.28	0.20	0.40	0.00	0.17	0.40
30	6	4	0.05	1.32	18.84	0.00	1.85	49.90	23.33	0.00	0.60	0.00	0.00	4.16
45	6	4	0.08	1.10	16.94	0.39	2.09	50.50	25.21	0.57	0.93	0.00	0.00	1.20
60	6	4	0.07	2.46	14.69	9.74	1.24	36.43	30.97	0.00	0.36	0.00	0.00	3.69

90	6	4	0.13	1.37	18.76	0.41	2.17	54.99	29.87	0.08	1.20	0.22	0.78	1.38
120	6	4	0.13	1.30	18.00	0.86	2.00	50.10	23.64	0.17	0.00	0.66	0.10	0.40

Table 6.1.2. FAME and gravimetric data for Soxhlet where PS is particle size (5- Big particle size, 6- small particle size), TRT is treatment (3- no treatment, 4 –biotreatment), C16:1 is palmitoelic acid and Lin is Linoleic acid.

PS	TRT	Weight (g)	Mystric	Palmitic	C16:1	Stearic	Oleic	Linoleic	γ Lin	α - Lin	h- γ Lin	ARA	EPA
5	4	27.41	0.89	13.19	0.28	2.02	45.87	31.03	0.83	1.23	0.35	1.12	1.84
6	4	28.71	0.89	13.57	0.29	1.99	46.28	31.19	0.72	1.24	0.29	0.87	1.46
5	3	22.34	0.33	15.98	0.18	2.21	47.02	31.68	0.00	1.31	0.00	0.00	0.00
6	3	22.39	0.38	15.96	0.18	2.06	46.36	32.50	0.00	1.32	0.00	0.00	0.00

APPENDIX E
SAS PROGRAMS

E.1. SAS program for data validation

```

dm 'output;clear;log;clear';
OPTIONS LS = 72;
DATA Timeglm;
INPUT TIME PS REP TRT WT cumtw t MA PA C161 ST OA LA GL AL C20 C201 C203
ARA EPA;
/*Particle size - 5 big , 6 small
Treatment - 3 No treatment, 4 Biotreatment
Extraction Type - 7 SFE, 8 soxhlet
*/
IF Time=90
Then WT = WT/2;
IF Time=120
Then WT = WT/2;
CARDS;
15 5 1 3 0.05 0.05 0.586803507 19.35174325 0
2.277939426 50.89647672 25.31713766 0 0.948372324 0.621527113 0
0 0 0
30 5 1 3 0.05 0.1 0.534154938 18.35998219 0
2.272682128 50.00457232 26.4810571 0 0.950479925 0.638055061
0.759016337 0 0 0
45 5 1 3 0.03 0.13 0.524009198 19.73678262 0
2.381360262 53.88605934 22.14257508 0 0.642582915 0.686630595 0
0 0 0
60 5 1 3 0.1484 0.2784 0.520083958 18.13491858 0
2.273942454 50.0211328 26.4303758 0 0.993167716 0.677881441
0.94849725 0 0 0
90 5 1 3 0.2012 0.4796 0 18.74111544 0
1.689486816 45.59302871 32.91144108 0 1.064927958 0 0 0
0 0
120 5 1 3 0.0734 0.553 0.411307917 16.95249382
0.222701273 1.952911346 45.64931398 32.4227467 0 1.381445875
0.557736622 0.449342477 0 0 0
15 5 2 3 0.056 0.056 0.546717102 17.10179251 0.358464543
2.077219537 46.45757238 31.06779047 0 1.31629886 0.594094268
0.48005033 0 0 0
30 5 2 3 0.0521 0.1081 0.55005959 17.46064097 0
1.9163574 46.23344472 31.47223091 0 1.370789564 0.49819782
0.498279028 0 0 0
45 5 2 3 0.0879 0.196 0.420896964 15.45446282
0.304841585 1.797537247 41.91781415 37.97658293 0 1.290594649
0.495757305 0.341512346 0 0
60 5 2 3 0.0534 0.2494 0.43971091 16.78187599
0.31454602 1.932164403 45.32999052 32.90409333 0 1.404863294
0.521541557 0.371213973 0 0 0
90 5 2 3 0.1441 0.3935 0.431804739 16.75843557
0.216171463 1.922772994 45.31479386 32.99374262 0 1.386535763
0.534853187 0.440889798 0 0 0
120 5 2 3 0.1605 0.554 0.393012983 16.69860907
0.220546256 1.956393228 45.45163747 32.91744773 0 1.388496853
0.531254154 0.442602262 0 0 0
15 6 2 3 0.1088 0.1088 1.131010981 22.90338641
0.85002164 1.966237658 48.89362648 23.34442126 0 0.911295572 0
0 0 0 0
30 6 2 3 0.0765 0.1853 0.849306006 19.94166463 0
1.823010905 46.96399765 28.78184598 0 1.166576406 0.473598423 0
0 0 0

```

45	6	2	3	0.0078	0.1931	0.478221855	16.72047683		
				0.341858842	1.861070426	45.61691207	32.70785492	0	1.33856138
				0.560724687	0.374318994	0	0	0	
60	6	2	3	0.1542	0.3473	0	17.44342304	0	0
				48.7424402	33.81413676	0	0	0	0
90	6	2	3	0.236	0.5833	0.458750609	16.63874887		
				0.36440972	1.915592381	45.64656823	32.5059325	0	1.33773155
				0.576315486	0.555950655	0	0	0	
120	6	2	3	0.1273	0.7106	0.504976764	17.44419819		
				0.352646599	1.842578372	45.67522163	31.90528916	0	1.299982223
				0.538710553	0.436396511	0	0	0	
15	6	1	3	0.0888	0.0888	0.536044774	16.34517021		
				0.318902696	1.953527438	45.81990954	32.62356771	0	1.304648091
				0.57172236	0.526507184	0	0	0	
30	6	1	3	0.0739	0.1627	0.902293705	20.895653		
				0.226113154	2.442139458	55.6583409	17.96199219	0	0.581164596
				1.084288663	0.248014335	0	0	0	
45	6	1	3	0.0984	0.2611	1.280404413	26.17969215		
				0.430235769	2.635593617	59.35243565	8.947956245	0	0.13287088
				0.739992478	0.3008188	0	0	0	
60	6	1	3	0.0706	0.3317	1.094222189	25.6221723		
				0.659683789	2.49481548	58.64238795	9.606880528	0	0.106526541
				0.886504656	0.886806575	0	0	0	
90	6	1	3	0.1716	0.5033	0.369073032	16.21241563		
				0.200284059	1.889197108	45.45319907	33.48826881	0	1.35628191
				0.563226369	0.468054012	0	0	0	
120	6	1	3	0.1717	0.675	0.552316673	18.35372827		
				0.119335208	1.866668957	46.46611765	30.44373656	0	1.22405752
				0.546404323	0.427634841	0	0	0	
15	5	1	4	0.0379	0.0379	1.212036448	14.06120802		
				0.350213311	1.883799767	45.29849766	31.53708618	0.730050221	
				1.268360393	0.514764922	0.387815941	0.222869143	0.927007165	
				1.606290835					
30	5	1	4	0.0787	0.1166	0.119005817	13.72798169		
				0.347295386	1.809768167	45.20131311	32.41531541	0.806363626	
				1.323687862	0.505220235	0.506513644	0.325212286	1.090330163	
				1.821992606					
45	5	1	4	0.0268	0.1434	1.161183948	13.7237059		
				0.369090954	1.745388708	44.6134222	32.25348002	0.825978811	
				1.315892572	0.454810712	0.413384972	0.302468619	1.061986959	
				1.759205629					
60	5	1	4	0.0636	0.207	1.134631276	13.58396523		
				0.353371814	1.772130568	44.5682681	32.09521536	0.834883618	
				1.304247651	0.555478965	0.480721892	0.460001279	1.056023596	
				1.801060661					
90	5	1	4	0.1259	0.3329	1.267451892	13.88850975		
				0.42310451	1.766066983	44.51604936	32.22730839	0.799061419	
				1.326928772	0.453704273	0.337887071	0.229872918	1.027544268	
				1.7365104					
120	5	1	4	0.102	0.4349	0.956195408	13.37693947		
				0.298248875	1.88670355	45.55980973	31.64574507	0.820163474	
				1.27904267	0.560835527	0.465597703	0.335254691	1.054564495	
				1.760899346					
15	5	2	4	0.0662	0.0662	1.201592703	14.3794172		
				0.35129445	1.957332233	46.65020821	29.57059224	0.673242348	
				1.189232214	0.602807994	0.678661412	0.211174722	0.925500298	
				1.608943977					

30	5	2	4	0.0211	0.0873	1.350620167	14.12545439				
				0.378789512	1.73668538	45.18224939	31.26462997	0.772674097			
				1.263614177	0.506371785	0.397721928	0	1.534978317	1.486210887		
45	5	2	4	0.0764	0.1637	1.165915209	13.61965672				
				0.36959464	1.737074719	44.78318744	32.22252313	0.817148847			
				1.321058615	0.482763991	0.503346675	0	1.059281026	1.918448991		
60	5	2	4	0.0855	0.2492	1.102465392	13.35859091				
				0.342342611	1.750862091	43.85750732	30.94699078	0.779722438			
				1.273623101	0.531490673	0.50502626	0	2.033996552	3.517381874		
90	5	2	4	0.1248	0.374	1.112973594	13.72362176				
				0.33493906	1.769896321	44.92017225	32.2251543	0.882864228			
				1.314918473	0.506559599	0.432173811	0.312937	0.912110578			
				1.551679028							
120	5	2	4	0.0897	0.4637	1.06648432	13.70718475				
				0.332573319	1.784503232	44.78416384	31.95098077	0.848809773			
				1.304223525	0.508957409	0.529010377	0.31545544	1.061623467			
				1.806029784							
15	6	2	4	0.0469	0.0469	1.190696565	18.01268503				
				0.463788384	2.192104415	51.85056437	22.42084042	0.441699311			
				0.834614461	0.853904159	0.867252654	0	0.871850227			
30	6	2	4	0.042	0.0889	1.623317718	23.12240758				
				0.697709981	2.272641581	54.7093982	15.03335942	0	0.420022678		
				0.910805422	0.842375093	0	0	0.367962328			
45	6	2	4	0.0673	0.1562	1.311822847	17.67659078				
				0.49698081	1.984179673	50.31228189	24.88251844	0.59015277			
				0.985170142	0.661615254	0	0	0	1.098687393		
60	6	2	4	0.0652	0.2214	1.349786593	17.96552853				
				0.48280177	1.894682663	49.58220273	24.23782008	0.55232276			
				0.939076951	0.632528238	0.668497331	0.124284474	0.56600919			
				1.004458698							
90	6	2	4	0.1322	0.3536	0.675653238	18.33241278	0			
				2.186952759	48.72448486	23.78365603	0	0	0.826313561	0	0
				0	5.47052677						
120	6	2	4	0.1177	0.4713	1.437676772	15.87159909				
				0.409539604	1.607063249	44.81662451	30.55919392	0.829191457			
				1.243771654	0.431552152	0.411129982	0.228651439	0.804569947			
				1.34943622							
15	6	1	4	0.1131	0.1131	1.366459558	22.61289358				
				0.433798245	2.344851211	55.87180603	14.2848716	0.197462006			
				0.398019073	0.91621612	0.998295219	0	0.173035406	0.402291949		
30	6	1	4	0.0482	0.1613	1.322244935	18.83651582	0			
				1.848286571	49.89690433	23.32998322	0	0.603400271	0	0	0
				0	4.162664855						
45	6	1	4	0.0761	0.2374	1.104486731	16.93774347				
				0.391374959	2.085542592	50.50474447	25.20596702	0.567583649			
				0.929834037	0.676263898	0.400657628	0	0	1.195801537		
60	6	1	4	0.0662	0.3036	2.456780741	14.69001438				
				9.744404972	1.237892958	36.42835519	30.96645882	0	0.361442266	0	0
				0.420614802	0	0	3.694035874				
90	6	1	4	0.1321	0.4357	1.373610491	18.75768687				
				0.411298759	2.165596988	54.99176776	29.87260169	0.077158332			
				1.198487881	0.726723226	0.758101885	0.217919831	0.777681517			
				1.383785696							
120	6	1	4	0.1267	0.5624	1.29806217	18.00139				
				0.858748	2.000917	50.09626	23.63953	0.16572	0		
				0.83647	0.649583	0.662353	0.102448	0.40466			

i

RUN;

```

PROC glm DATA = TIMEglm ;
CLASS PS TRT TIME REP ;
  * WHERE TRT= 3;
MODEL WT MA PA C161 ST OA LA GL AL C20 C201 C203 ARA EPA = PS TRT TIME REP
TRT*PS;
LSMEANS TRT PS TRT*PS/ADJUST = TUKEY STDERR pdiff;
output out= rb2;
/* proc means data = timeglm MEAN ;
  class TRT ps ;
  MA PA C161 ST OA LA GL AL C20 C201 C203 ARA EPA ;
  output out = rb2 mean=MA PA C161 ST OA LA GL AL C20 C201 C203 ARA EPA ;
run;
proc print data = rb2;
RUN;*/
QUIT;

```

E.2. SAS Program for calculating diffusivity

This program determines the diffusivity for spherical geometries
 *using Crank's analytical solution to Fick's 2nd Law up to 13 terms
 *of the infinite series solution.

```

* model y = 1 - ((6/pi_sq) * term1);
* term1 = exp(-dw*pi_sq*min/a_sq);
* where y=dependent variable
*       min= minutes converted to seconds
*       dw=diffusivity (cm^2/s)
*       pi_sq = pi squared
*       a_sq = radius squared (cm)(see Appendix c.2)

```

```

OPTIONS LS=72;

```

```

DATA SFE;

```

```

INPUT TIME PS REP TRT WT cumwt;

```

```

MIN = TIME*60;

```

```

  pi_sq = 9.8696044 ;

```

```

  IF PS = 5 then

```

```

    a_sq = .0016 ;

```

```

    IF PS = 6 then

```

```

      a_sq = .0004477

```

```

    ;

```

```

CARDS;

```

15	5	1	3	0.05	0.05
30	5	1	3	0.05	0.1
45	5	1	3	0.03	0.13
60	5	1	3	0.1484	0.2784
90	5	1	3	0.2012	0.4796
120	5	1	3	0.0734	0.553
15	5	2	3	0.056	0.056
30	5	2	3	0.0521	0.1081
45	5	2	3	0.0879	0.196
60	5	2	3	0.0534	0.2494
90	5	2	3	0.1441	0.3935
120	5	2	3	0.1605	0.554
15	6	2	3	0.1088	0.1088
30	6	2	3	0.0765	0.1853
45	6	2	3	0.0078	0.1931
60	6	2	3	0.1542	0.3473

90	6	2	3	0.236	0.5833
120	6	2	3	0.1273	0.7106
15	6	1	3	0.0888	0.0888
30	6	1	3	0.0739	0.1627
45	6	1	3	0.0984	0.2611
60	6	1	3	0.0706	0.3317
90	6	1	3	0.1716	0.5033
120	6	1	3	0.1717	0.675
15	5	1	4	0.0379	0.0379
30	5	1	4	0.0787	0.1166
45	5	1	4	0.0268	0.1434
60	5	1	4	0.0636	0.207
90	5	1	4	0.1259	0.3329
120	5	1	4	0.102	0.4349
15	5	2	4	0.0662	0.0662
30	5	2	4	0.0211	0.0873
45	5	2	4	0.0764	0.1637
60	5	2	4	0.0855	0.2492
90	5	2	4	0.1248	0.374
120	5	2	4	0.0897	0.4637
15	6	1	4	0.1131	0.1131
30	6	1	4	0.0482	0.1613
45	6	1	4	0.0761	0.2374
60	6	1	4	0.0662	0.3036
90	6	1	4	0.1321	0.4357
120	6	1	4	0.1267	0.5624
15	6	2	4	0.0469	0.0469
30	6	2	4	0.042	0.0889
45	6	2	4	0.0673	0.1562
60	6	2	4	0.0652	0.2214
90	6	2	4	0.1322	0.3536
120	6	2	4	0.1177	0.4713

;

proc nlin;

parms dw = **1.0e-6** ;
term1 = exp(-dw*pi_sq*min/a_sq);

model cumwt = 1 - ((6/pi_sq) * term1);

title1 '1 term TRT=60';

*****;

proc nlin;

parms dw = **1.0e-6**;
term1 = exp(-dw*pi_sq*min/a_sq);
term2 = (1/4)*exp(-dw*4*pi_sq*min/a_sq);

model cumwt = 1 - ((6/pi_sq) * (term1 + term2));

title1 '2 terms, tmt 60';

*****;

```

proc nlin;
  parms dw = 1.0e-6;
  term1 = exp(-dw*pi_sq*min/a_sq);
  term2 = (1/4)*exp(-dw*4*pi_sq*min/a_sq);
  term3 = (1/9)*exp(-dw*9*pi_sq*min/a_sq);
  term4 = (1/16)*exp(-dw*16*pi_sq*min/a_sq);
  term5 = (1/25)*exp(-dw*25*pi_sq*min/a_sq);

  model cumwt = 1 - ((6/pi_sq) * (term1 + term2 + term3
                                + term4 + term5));

  title1 '5 terms, tmt = 60';

*****;

```

```

proc nlin;

  parms dw = 1.0e-6;

  term1 = exp(-dw*pi_sq*min/a_sq);
  term2 = (1/4)*exp(-dw*4*pi_sq*min/a_sq);
  term3 = (1/9)*exp(-dw*9*pi_sq*min/a_sq);
  term4 = (1/16)*exp(-dw*16*pi_sq*min/a_sq);
  term5 = (1/25)*exp(-dw*25*pi_sq*min/a_sq);
  term6 = (1/36)*exp(-dw*36*pi_sq*min/a_sq);
  term7 = (1/49)*exp(-dw*49*pi_sq*min/a_sq);
  term8 = (1/64)*exp(-dw*64*pi_sq*min/a_sq);
  term9 = (1/81)*exp(-dw*81*pi_sq*min/a_sq);
  term10 = (1/100)*exp(-dw*100*pi_sq*min/a_sq);

  model cumwt = 1 - ((6/pi_sq) * (term1 + term2 + term3
                                + term4 + term5 + term6 + term7 + term8
                                + term9 + term10));

  title1 '10 terms, tmt = 60';

```

```

proc nlin data=SFE;

  parms dw = 1.0e-6;

  term1 = exp(-dw*pi_sq*min/a_sq);
  term2 = (1/4)*exp(-dw*4*pi_sq*min/a_sq);
  term3 = (1/9)*exp(-dw*9*pi_sq*min/a_sq);
  term4 = (1/16)*exp(-dw*16*pi_sq*min/a_sq);
  term5 = (1/25)*exp(-dw*25*pi_sq*min/a_sq);
  term6 = (1/36)*exp(-dw*36*pi_sq*min/a_sq);
  term7 = (1/49)*exp(-dw*49*pi_sq*min/a_sq);
  term8 = (1/64)*exp(-dw*64*pi_sq*min/a_sq);
  term9 = (1/81)*exp(-dw*81*pi_sq*min/a_sq);
  term10 = (1/100)*exp(-dw*100*pi_sq*min/a_sq);
  term11 = (1/121)*exp(-dw*100*pi_sq*min/a_sq);
  term12 = (1/144)*exp(-dw*100*pi_sq*min/a_sq);
  term13 = (1/169)*exp(-dw*100*pi_sq*min/a_sq);

  model cumwt = 1 - ((6/pi_sq) * (term1 + term2 + term3 + term4 + term5
                                + term6 + term7 + term8 + term9 + term10 + term11
                                + term12 + term13));

  title1 '13 terms, tmt = 60';
  output out=fun60 p=yp r=res60;

```

```
proc plot; plot cumwt*min yp*min='*'/overlay vpos=40;
PROC GLM; CLASS TIME PS REP TRT;
MODEL cumwt =TIME PS REP TRT;
LSMEANS TRT PS;
RUN;
*          plot res2*min/ vref=0 vpos=30;
*          plot y2u95*min='u' y2l95*min='l'
*          yp2*min='*'/overlay vpos=40;
proc print data=fun60;
```

VITA

Rohit Badal was born on January 4, 1976, at Dewas, India, to R.S. Badal and Saroj Badal. He was formally educated at St. Mary's convent school at Dewas, India, and passed the pre-engineering exam at the state level for starting Bachelor of Technology program in chemical and biological engineering at Regional Engineering College, Jalandhar. He completed the Bachelor of Technology in 1998 and joined Omen Drugs as Trainee Engineer for one year. On August 1999, He entered the graduate program at Louisiana State University. From August 1999 to July 2002, he worked as a Research Assistant at the Department of Biological and Agricultural Engineering. This thesis completed his requirements to receive the degree of Master of Science in Biological and Agricultural Engineering