

ROLE OF CHONDROCYTE APOPTOSIS IN THE PATHOGENESIS OF EQUINE
OSTEOARTHRITIS

A Dissertation

Submitted to the Graduate Faculty of the
Louisiana State University and
Agricultural and Mechanical College
In partial fulfillment of the
Requirements for the degree of
Doctor of Philosophy

In

The Interdepartmental Programs in Veterinary Medical Sciences
through the Department of Pathobiological Sciences

by

Dae Young Kim
D.V.M., Seoul National University, Korea, 1991
M.S., Seoul National University, Korea, 1995
May 2002

ACKNOWLEDGMENTS

I would like to sincerely thank Drs. Cho and Taylor who warmly welcomed me to the departmental family five years ago. They have provided me both with the opportunity to study veterinary pathology and the generous, continuous, advice and encouragement needed to complete my training. This project would not have been possible without their efforts and the financial support of the department. I am also thankful to the other members of my graduate committee: Dr. Paulsen who kindly became my committee member when I desperately needed him, Dr. Moore who I admire for his professionalism and his enthusiasm toward research, and Dr. Manhein, “The Bone Lady”, who showed me the interesting world of forensic anthropology. I also appreciate Drs. Goad and Oliver who gave me the opportunity to study this project. Thanks to the many veterinary pathologists who have generously shared their expertise in my residency training: Drs. Bauer, Evans, Gaunt, Hodgins, Johnson, and Snider. Special thanks to Dr. Barker and Marian Waguespack in the department of Comparative Biomedical Sciences. They freely opened the door for me when I needed technical support for the HPLC equipment. I am thankful to Dr. Rhett Stout and Michael L. Kearney who helped me to solve statistical problems.

I am grateful to department staff. I won't forget the kindness and countless support from Cheryl, Del, Hal, Julie, Kendra, Pam, Petesie, and Thaya. I am especially indebted to Mae Lopez. She has been my colleague, counselor, guardian, and friend. She will always have a special place in my heart.

I thank my fellow pathology residents, past and present, for sharing my graduate experience and sweet memories at LSU: Tom Vicek, Ureal Blas, Thomas Lemarchand, Al Camus, Kristina Porthouse, Chris Roberts, and Wael Hananeh.

Most importantly, I thank my grandmother, parents, and parents-in laws who have provided me the encouragement through this endeavor, and my wife, Yumi, and my son, Mingu, for their patience, understanding, and love during this work.

TABLE OF CONTENTS

ACKNOWLEDGMENTS.....	ii
LIST OF TABLES.....	v
LIST OF FIGURES.....	vi
ABSTRACT.....	viii
INTRODUCTION.....	1
CHAPTER I: LITERATURE REVIEW.....	5
Articular Cartilage.....	5
Normal Articular Cartilage.....	5
Articular Cartilage in Osteoarthritis.....	7
Osteoarthritis in Horses.....	9
Apoptosis.....	10
Apoptosis and Necrosis.....	10
Mechanisms of Apoptosis.....	11
1. Apoptotic Death Signals.....	11
2. Activation of Caspases.....	12
3. Bcl-2 Family Proteins.....	14
4. Inhibitors of Apoptosis Proteins.....	15
5. Protein Degradation and DNA Fragmentation.....	15
6. Phagocytic Recognition.....	16
CHAPTER II: CHONDROCYTE APOPTOSIS IN EQUINE OSTEOARTHRITIS.....	18
Introduction.....	18
Materials and Methods.....	19
Equine Articular Cartilage.....	19
Histopathologic Evaluation.....	19
<i>In situ</i> Detection of Chondrocyte Apoptosis.....	19
Immunohistochemistry for Nitrotyrosine.....	20
Data Analysis.....	21
Results.....	21
Histopathologic Evaluation.....	21
Chondrocyte Apoptosis.....	21
Correlation between Histopathologic Grade and Chondrocyte Apoptosis.....	25
Detection of Nitrotyrosine.....	25
Discussion.....	27

CHAPTER III: CYCLIC HYDROSTATIC PRESSUE INDUCES EQUINE CHONDROCYTE APOPTOSIS.....	29
Introduction.....	29
Materials and Methods.....	30
Equine Chondrocyte Isolation.....	30
Construction of Alginate Beads.....	30
Application of Hydrostatic Pressure.....	31
Immunocytochemistry for Chondrocyte Apoptosis.....	31
Quantification of Chondrocyte Apoptosis and Statistical Analysis.....	33
Results.....	33
Discussion.....	38
 CHAPTER IV: INCREASED NITRIC OXIDE PRODUCTION AND BCL-2 AND CASPASE-3 EXPRESSION BY EQUINE ARTICULAR CHONDROCYTES UNDER CYCLIC HYDROSTATIC PRESSURE: LINKAGE TO CHONDROCYTE APOPTOSIS.....	42
Introduction.....	42
Materials and Methods.....	43
Equine Chondrocyte Isolation.....	43
Application of Hydrostatic Pressure.....	44
Nitrite Assay.....	45
Immunocytochemistry for Bcl-2 and Caspase-3.....	45
Data Analysis.....	46
Results.....	46
Nitrite Assay.....	46
Immunocytochemistry for Bcl-2.....	46
Immunocytochemistry for Caspase-3.....	50
Discussion.....	52
 SUMMARY.....	56
 BIBLIOGRAPHY.....	58
 VITA.....	71

LIST OF TABLES

2.1. Histopathologic criteria for osteoarthritis.....	20
2.2. Percentage of apoptotic cells in equine articular cartilage (mean \pm SD).....	23
3.1. Apoptosis of pressure-loaded and control chondrocytes isolated from superficial and deep layers of equine articular cartilage (mean \pm SD).....	34
3.2. Relative increase of chondrocyte apoptosis in the pressure-loaded experimental groups compared with the corresponding control groups (mean \pm SD).....	35
4.1. Nitrite concentration from pressure-loaded and control chondrocytes from equine articular cartilages ($\mu\text{M}/10^3$ cells).....	47

LIST OF FIGURES

2.1. Equine normal articular cartilage. No microscopic abnormalities are noted.....	22
2.2. Articular cartilage from an osteoarthritic horse. Note the severe fibrillation of the articular surface and chondrocyte clustering (cloning).....	22
2.3. TUNEL staining for detecting DNA fragmentation in equine normal articular cartilage. No cells with positive immunoreactivity are noted.....	24
2.4. TUNEL staining for detecting DNA fragmentation in equine osteoarthritic articular cartilage. Note positive immunoreactivity in the clusters of chondrocytes in the areas of fibrillation.....	24
2.5. Correlation between histopathologic grade and chondrocyte apoptosis ($p < 0.001$).....	25
2.6. Immunohistochemistry for nitrotyrosine in equine normal articular cartilage. Positive immunoreactivity is limited to the chondrocytic cytoplasm and the pericellular matrix in the superficial and upper middle layers.....	26
2.7. Immunohistochemistry for nitrotyrosine in equine osteoarthritic articular cartilage. Note intensely positive immunoreactivity of the chondrocytes as well as cartilage matrix in a diffuse pattern in the areas of fibrillation.....	26
3.1. Hydrostatic pressure loading system.....	32
3.2. TUNEL staining for detection of apoptotic chondrocytes. The control chondrocytes that were isolated from superficial layers of equine articular cartilage and were not subjected to pressure. No chondrocytes are positively stained.....	36
3.3. TUNEL staining for detection of apoptotic chondrocytes. The chondrocytes were isolated from superficial layers of equine articular cartilage and pressured with a cyclic hydrostatic pressure of 6.8 MPa for 12 hours. Note increased apoptotic chondrocytes over the control.....	36
3.4. TUNEL staining for detection of apoptotic chondrocytes. The control chondrocytes that were isolated from deep layers of equine articular cartilage and were not subject to pressure. A few chondrocytes shows immunopositivity.....	37
3.5. TUNEL staining for detection of apoptotic chondrocytes. The chondrocytes were isolated from deep layers of equine articular cartilage and pressured with a cyclic hydrostatic pressure of 6.8 MPa for 12 hours. Note increased apoptotic chondrocytes over the control.....	37

4.1. Immunocytochemistry for Bcl-2 in the control chondrocytes isolated from superficial layers of equine articular cartilages. The cytoplasm is partially stained with fine chromogen particles.....48

4.2. Immunocytochemistry for Bcl-2 in the hydrostatic pressure-loaded chondrocytes isolated from superficial layers of equine articular cartilages. Note the stronger immunopositivity compared with the control.....48

4.3. Immunocytochemistry for Bcl-2 in the control chondrocytes isolated from deep layers of equine articular cartilages. The cytoplasm is partially stained with fine chromogen granules while immunopositivity appears stronger than the control chondrocytes from superficial layers.....49

4.4. Immunocytochemistry for Bcl-2 in the hydrostatic pressure-loaded chondrocytes isolated from deep layers of equine articular cartilages. The cytoplasm is diffusely and strongly stained.....49

4.5. Immunocytochemistry for caspase-3 in the control chondrocytes isolated from superficial layers of equine articular cartilages. Note diffusely stained cytoplasm and occasional densely stained nuclei.....50

4.6. Immunocytochemistry for caspase-3 in the hydrostatic pressure-loaded chondrocytes isolated from superficial layers of equine articular cartilages. The densely stained nuclei are more frequent and the cytoplasm shows increased immunopositivity over the control.....51

4.7. Immunocytochemistry for caspase-3 in the control chondrocytes isolated from deep layers of equine articular cartilages. Note diffusely stained cytoplasm and occasional densely stained nuclei.....51

4.8. Immunocytochemistry for caspase-3 in the hydrostatic pressure-loaded chondrocytes isolated from deep layers of equine articular cartilages. Note frequently stained nuclei as well as much stronger immunopositivity in the cytoplasm compared with the control.....52

ABSTRACT

Osteoarthritis (OA), a non-inflammatory, degenerative disease of articular cartilages, is a common cause of poor performance and early retirement in equine athletes. Pathologically, OA is characterized by matrix degradation and decreased chondrocyte numbers. A mechanical stress is believed to be the major etiologic factor of OA development. Recent studies have indicated that apoptosis is responsible for hypocellularity in OA cartilage and that chondrocyte death by apoptosis could directly contribute to matrix degradation. Increased nitric oxide (NO), a free radical, has been implicated as a cause of chondrocyte apoptosis. No studies, however, have been performed on chondrocyte apoptosis in equine OA. We investigated chondrocyte apoptosis in equine OA cartilage and its relationship to matrix degradation and NO production. Furthermore, we studied whether mechanical stress could induce chondrocyte apoptosis and how NO production and Bcl-2 and caspase-3 proteins contribute to chondrocyte apoptosis by using a novel pressure-loading system. Five OA and three normal equine articular cartilage samples were graded histopathologically and stained with polyclonal nitrotyrosine antibody. Chondrocyte apoptosis was determined by TUNEL assay. For pressure-loading experiment, equine chondrocytes were isolated separately from superficial and deep layers of articular cartilages, embedded in alginate constructs, and intermittently pressurized at $1,000 \pm 100$ psi (approximately 6.8 ± 0.6 MPa) for 12 hours. TUNEL assay, immunohistochemistry with polyclonal antisera to Bcl-2 and caspase-3, and colorimetric nitrite assay were applied to the chondrocytes that adhered on glass slides by cytospin. Chondrocyte apoptosis occurred much more frequently in equine OA cartilage than in normal cartilage, and was closely correlated with matrix degradation and NO production. The cyclic hydrostatic pressure-treated chondrocytes had a higher percentage of apoptosis than the controls. The pressure-loaded chondrocytes also produced increased NO and expressed elevated Bcl-2 and caspase-3, as compared with the control groups. The present study suggests that pressure-induced NO levels play a critical role in the equine chondrocyte apoptosis process through Bcl-2 and caspase-3 pathways and mechanical stress may contribute to equine OA pathogenesis via chondrocyte apoptosis induced by endogenous NO.

INTRODUCTION

Joint pain and loss of mobility are among the leading causes of impairment in middle-aged and old people. One of the most important social changes that has occurred in recent decades is the increased longevity of the population. Today, almost 80% of the population can expect to live for over 70 years and in the United States, by the year 2050, there will be 16 million people in the 85 and older group (Kraus 1997). Autopsy studies demonstrate that 60 to 70 % of people in their 60s and 70s have evidence of osteoarthritis in their knees (Felson 1988, Copper 1994). Osteoarthritis (OA) is the most common form of joint disease and is generally age-related. According to the review by Kraus (1997), arthritis affects approximately 15% of the total U.S. population, approximately 40 million adults, and, of these, 16 million (43%) are affected by OA. By the year 2020, owing to the aging of the population, the prevalence of arthritis is estimated to reach 18.2%, involving more than 59 million people. In 1996, people who had musculoskeletal disorders spent an average of \$3,578 per person for their medical care in the U.S., which was a total of \$193 billion in the nation, the equivalent of 2.5% of the Gross Domestic Product in that year (Yelin et al. 2001). With increasing longevity of the population, it becomes more important to find ways to decrease the clinical and financial impact of OA.

OA is also a common cause of lameness and poor performance in horses. Lameness, in general, has been estimated to account for 68% of the number of training days lost per year in a population of young Thoroughbred racehorses (Rossdale et al. 1985). One study shows that OA was responsible for 54% of lame horses (Todhunter and Lust 1992).

OA is pathologically characterized by degradation of cartilage matrix and chondrocytic death. The pathogenesis of OA is still not fully understood but believed to be multifactorial including genetic, environmental, metabolic, and biomechanical factors (Buckwalter and Mankin 1998). Recent studies using electron microscopy, flow cytometry, and the DNA fragmentation assay (TUNEL) have shown that apoptosis is the major pathway of the chondrocytic death in the articular cartilage of OA (Blanco et al. 1998, Hashimoto et al. 1998a, Hashimoto et al. 1998b, Hashimoto et al. 1998c, Lotz et al. 1999).

One of the pivotal questions in OA pathogenesis is whether chondrocytic apoptosis is the result of or the cause of matrix damage. Hashimoto et al. (1998a) reported that high numbers of apoptotic chondrocytes were noted in some macroscopically normal human articular cartilage samples in the control group and suggested that chondrocyte apoptosis may precede the manifestations of OA. In human OA, there are other indirect evidences suggesting that chondrocyte apoptosis may contribute to the onset of OA. Human OA is a mainly age-related disease. One of the remarkable changes of cartilage in the human aging population is a diffuse and profound loss of chondrocytic cellularity (up to 50% decrease) with an increase in the number of empty lacunae, matrix calcification, and fibrillation in the superficial layer (Stockwell 1971, Buckwalter and Mankin 1998). An electron microscopic study revealed that the empty lacunae were membrane-bound apoptotic bodies containing cell remnants (Blanco et al. 1998). In addition, those chondrocyte-derived apoptotic bodies contain abundant pyrophosphohydrolase that precipitate calcium, resulting in calcification of the articular cartilage (Hashimoto et al. 1998b). These findings further suggest that chondrocytic apoptosis may be a predisposition to the human OA. Furthermore, those areas in which apoptotic chondrocytes exist are geometrically correlated with matrix degradation (Hashimoto et al. 1998a).

Not only is primary (idiopathic, age-related, or genetic) OA associated with chondrocytic apoptosis, but is also associated with the trauma (joint instability) -induced secondary OA. In human OA, although primary OA most frequently occurs, there are some speculations that primary OA may also result from joint injury (Kraus 1997, Buckwalter and Mankin, 1998). In experimental OA in rabbit knee joints, induced by anterior cruciate ligament transection, it was revealed that a close correlation existed between extracellular matrix degradation and levels of chondrocytic apoptosis (Hashimoto et al. 1998c).

In horses, traumatic injury has been suggested to be a common cause of OA. This may be a single event trauma, leading to what may be a clearly definable injury to one or more joint structures, or more insidious repetitive traumatic insults. Development of equine OA is often associated with stresses of racing and training (Cantley et al. 1999). No studies, however, have been performed on chondrocyte apoptosis in equine OA.

Articular cartilage is a load-bearing tissue and mechanical stress is believed to be a major factor of OA, which has been proven by a number of studies using *in vivo* and *in vitro* experimental systems (Burton-Wurster et al. 1993, Lee et al. 1998, Steinmeyer et al. 1999a, Steinmeyer and Ackermann 1999b). In an *in vitro* study, Burton-Wurster et al. (1993) reported that intensely stained necrotic cells were noted in the superficial layers of canine cartilage explants that were subjected to compressive loads. Recently, *in vitro* studies have shown that a repetitive high impact mechanical loading on bovine articular cartilage explants induces chondrocyte apoptosis, and the number of apoptotic cells was correlated with the frequency, strength, and duration of applied mechanical pressure (Loening et al. 2000, Chen et al. 2001, Clements et al. 2001).

Articular cartilage, however, is not a homogeneously uniform tissue, but rather demonstrates a variety of anatomical and biochemical differences, depending on the locations of the samples taken (Arokoski et al. 1998, Brama et al. 1999, Brama et al. 2000). Because of the diversity existing between the articular cartilage samples (explants), standardization of the experimental condition can be problematic. To resolve this problem, an *in vitro* experimental system using chondrocytes is greatly needed. An *in vitro* experimental design to study hydrostatic pressure-induced chondrocyte apoptosis using cultured chondrocytes has not been established mainly due to technical difficulties of how to pressurize chondrocytes *in vitro* while retaining intact chondrocyte morphological characteristics.

Nitric oxide (NO) is a free radical, acting as a pathophysiological mediator (Liaudet et al. 2000). Endogenously produced NO is relevant to chondrocyte apoptosis and destruction of extracellular matrix *in vivo* (Blanco et al. 1998; Hashimoto et al. 1998a; Hashimoto et al. 1998c; Pelletier et al. 1998; Hashimoto et al. 1999). NO production, in the form of nitrites, increases in mechanically compressed articular cartilage explants (Loening et al. 2000), but detailed mechanisms of how NO is integrated in the apoptosis cascade is still not fully understood.

Bcl-2 is an anti-apoptotic protein that is located in the outer membrane of mitochondria and prevents mitochondrial permeabilization and release of cytochrome c, which eventually activates a series of execution caspases to result in cell demise by apoptosis (Yang et al. 1997). Expression of Bcl-2 is elevated in OA articular cartilage (Kim et al. 2000;

Pelletier et al. 2000). Increased expression of caspase-3 also occurs in OA articular cartilage and is correlated with the severity of OA (Matsuo et al. 2001). Caspase-3 is up-regulated in chondrocyte apoptosis induced by exogenous NO (Notoya et al. 2000; Kim et al. 2002).

Hypotheses of this study were 1) mechanical stress directly induces chondrocyte apoptosis resulting in matrix degeneration and 2) NO plays an important role in mechanical stress-induced chondrocyte apoptosis.

The specific goals of this study were:

- 1) To investigate whether chondrocyte apoptosis occurs in the articular cartilage of horses with OA and to examine the relationships of chondrocyte apoptosis with cartilage degeneration and levels of NO production *in vivo*.
- 2) To establish a hydrostatic pressure-loading system and to test a hypothesis that mechanical force directly causes chondrocytic apoptosis *in vitro*.
- 3) To examine the relationships between hydrostatic pressure-induced chondrocyte apoptosis and levels of apoptosis-related biological mediators such as NO, Bcl-2 and caspase-3 *in vitro*.

CAPTER I: LITERATURE REVIEW

Articular Cartilage

Normal Articular Cartilage

Articular cartilage is a thin layer of deformable, load-bearing material that lines the bony ends of diarthrodial joints. The primary functions of articular cartilage are to support and distribute forces generated during joint loading, stabilize and guide joint motions, and contribute to joint lubrication (Mow et al. 1992). Articular cartilage is composed of chondrocytes (1 to 2 % of the dry tissue volume) embedded in extracellular matrix (98 to 99% of the dry tissue volume). The cartilage extracellular matrix is produced and maintained by the chondrocytes, which are the only cells in the cartilage. There are three anatomical layers of articular cartilage through the tissue depth: (1) Superficial (surface) layer characterized by flattened disc-shaped chondrocytes; (2) Middle (transitional) layer where the chondrocytes are rounded and separated from each other with abundant cartilage matrix; and (3) Deep layer characterized by rounded chondrocytes arranged in columns (Archer et al. 1994). The main components of extracellular matrix are collagens and proteoglycans. Type II collagen, which represents approximately 95% of the total collagen weight (Scher et al. 1996), is the major component of the matrix, with minor amounts of types VI, IX, X, and XI collagens normally present (Heinegard and Oldberg 1989, Eyre et al. 1992). The collagen fibrillar network acts as both a structural framework to provide mechanical support to the tissue, and as a binding surface for molecules involved in mediating either matrix-matrix or cell-matrix interactions (Scher et al. 1996). Type IX collagen serves to link type II collagen fibrils and connect type II collagen to the matrix proteoglycans (Brierley et al. 1991, Aigner et al. 1993).

The large, aggregating proteoglycan in articular cartilage is known as aggrecan. Aggrecan consists of a core protein with multiple glycosaminoglycan side chains covalently attached. The core protein has three globular molecular domains, G1, G2, and G3, and hyaluronic acid binds to the N-terminal of G1 domain (Scher et al. 1996). Proteoglycan aggregates are formed by the binding of many proteoglycan monomers to a chain of hyaluronic acid. The proteoglycans affect the cartilage's mechanical and physical properties, such as compressive stiffness, shear stiffness, osmotic pressure, and regulation of hydration

(Buckwalter et al. 1994). The proteoglycan molecule has been one of the main targets as an OA marker, because it can represent the degree of cartilage synthesis, repair, and degeneration (Saxne et al. 1987, Silverman et al. 1990, Ratcliffe et al. 1993).

Articular cartilage is saturated with water. The water phase of cartilage constitutes from 65 to 85% of the total tissue weight and is important in controlling many physical properties. The proteoglycans are negatively charged due to the presence of carboxyl and sulfate groups on the glycosaminoglycans which confer a net negative charge on the cartilage extracellular matrix. As a result, cartilage is highly hydrophilic, with a tendency to imbibe fluid, or swell, in order to maintain mechanochemical equilibrium. This property contributes significantly to the mechanical function of articular cartilage by generating a large swelling pressure against deformations (Setton et al. 1999).

Biomechanical composition and arrangement of collagens and proteoglycans in the matrix differ by the anatomical location. Collagen fibers in the superficial layer of articular cartilage are densely packed and oriented parallel to the articular surface (Clark 1991). Thus, a relatively low proteoglycan content and a low permeability to fluid flow are characteristics of the superficial layer (Mansour and Mow 1976, Mow et al. 1984, Setton et al. 1993). In the middle layer, the collagen fibers are either random or radially oriented (Clark 1991) and the proteoglycan content is at a maximum value for the tissue (Venn and Maroudas 1977). In the deep layer, the collagen fibers are larger and form bundles, which are oriented perpendicular to the subchondral bone (Clark 1991) and the proteoglycan content is low (Venn and Maroudas 1977).

One of the unique anatomical characteristics of articular cartilage is avascularity (Gardner 1994). Therefore, articular chondrocytes rely on fluid-mediated nutritional delivery from the synovial fluid (Mow et al. 1984). Low molecular weight solutes, such as glucose, are transported by simple diffusion, but a mechanical pumping action of articular cartilage during joint movement is probably associated with the supply for large molecular weight solutes, such as serum albumin, by continuous expulsion and imbibition of interstitial fluid. This idea has been supported by signs of cartilage degeneration when there is no rhythmic stressing (Salter et al. 1980; Kiviranta et al. 1987).

Articular Cartilage in Osteoarthritis

OA is a non-inflammatory, degenerative joint disease, which is also referred as degenerative osteoarthritis, osteoarthrosis, and hypertrophic osteoarthritis. Despite concentrated research on OA in recent years, the pathogenesis of OA is still not fully understood. The causes of OA are believed to be multifactorial including genetic, environmental, metabolic, and biomechanical. OA can be grouped into primary (idiopathic) OA and secondary OA that has identifiable risk factors and causes (Buckwalter and Mankin 1998). Primary OA is the most common form in the human (prevalently in the elderly) and the cause is unknown (idiopathic). On the other hand, secondary OA can arise as a result of joint injury or a physiopathological alteration of cartilage matrix or subchondral bone caused by hereditary, developmental, metabolic, and neurologic disorders (Buckwalter and Mankin 1998). Risk factors associated with OA include age, obesity (Nevitt and Lane 1999, Sharma et al. 2000), high bone mineral density (Nevitt et al. 1995), joint hypermobility and instability (Howell et al. 1992), joint trauma, immobilization, peripheral neuropathy (due to syphilis, diabetes mellitus, leprosy, etc.), crystal formation in cartilage (Felson 1993), and repetitive joint overuse (Anderson and Felson 1988, Felson 1988, Felson et al. 1991). Effect of estrogen on the development of OA remains controversial (Sandmark et al. 1999, Wluka et al. 2001). Smoking, however, is believed to protect against development of severe forms of OA (Lavernia et al. 1999, Sandmark et al. 1999).

The degeneration or progressive loss of normal structure and function of articular cartilage is the fundamental tenant of osteoarthritis. Studies on changes of collagens in OA indicate a very slow turnover of collagen type II in vivo in adult humans, and the small amounts of the “minor” collagens present in the matrix (Maroudas 1980). A shift in the collagen composition in OA cartilage matrix occurs with increased concentrations of collagen types I and III, which are considered as “noncartilage” collagens (Aigner et al. 1993). Type X collagen is normally present only in sites near cartilage mineralization where chondrocytes are hypertrophic (Grant et al. 1985). In OA, several investigators have reported an increased expression of collagen type X both at sites of osteophytes and in clusters of chondrocytes in fibrillated cartilage matrix (Hoyland et al. 1991). Type VI collagen is normally located in the pericellular areas surrounding articular chondrocytes. The fact that cartilage with OA is

enriched in collagen type VI suggests that synthesis of this collagen is also activated in OA (Poole 1991).

Major shifts are found in the turnover and structure of aggrecan in both experimental and human OA. Synthesis of aggrecans increases in advancing OA, while in advanced OA, incorporation rate of aggrecans to other extracellular matrix molecules decreases (Bulstra et al. 1989). The structure of the newly synthesized aggrecan molecules in OA cartilage appears to differ from that of normal cartilage. Molecules synthesized as a response to the early phases of OA were reported to be of larger hydrodynamic sizes than normal, with longer chondroitin sulphate chains (Bulstra et al. 1989). Alterations of the sulphation patterns of the chondroitin sulphate chains as a response to OA are indicative of modified synthesis of aggrecan molecules (Rizkalla et al. 1992). The functional significance of this modification is unknown, but it is possible that it could alter the interaction of the glycosaminoglycan chains with growth factors or with other components of the matrix (Bayliss 1992). A consistent finding in experimental and human OA cartilage is an increased release of both pre-existing and newly synthesized aggrecan (Inerot et al. 1991).

It is generally assumed that the destruction of joint cartilage matrix in OA is caused by the action of proteases, which are released by the chondrocytes themselves, by cells in the synovial fluid such as leukocytes and macrophages, or by cells in the synovium. Proteolytic enzymes are classified into four distinct types depending on their catalytic mechanism: serine proteinases, cystein proteinases, aspartic proteinases and metalloproteinases (Barrett and Saklatvala 1985). Matrix metalloproteinases (MMP's), synthesized both by chondrocytes and by synovial cells (Woessner 1991; Clegg et al. 1997), are involved in the degradation of cartilage collagens during the development of OA (Lohmander 1994; Freemont et al. 1997). MMP's are a group of zinc dependent endopeptidases that are centrally involved in the normal physiological turnover of the extracellular matrix. The MMP's can be divided into three groups: collagenases (MMP 1 and 8), type IV collagenases/gelatinases (MMP 2 and 9), and stromelysins/proteoglycanases (MMP 3 and 10) (reviewed by Clegg et al. 1997).

When the articular cartilage is damaged, there is an initial increase in the water content of the cartilage. As the collagen lattice of the matrix is disrupted, more water is attracted to the negatively charged glycosaminoglycan chains, resulting in swelling of the

cartilage. Once the surface layer of cartilage is fibrillated, the resistance to shear forces is lessened and, as OA progresses, the cartilage develops deep clefts and matrix disruption occurs. The fissures usually form vertically because the collagen fibers are vertically oriented in the deep cartilage layers (reviewed by Kidd et al. 2001).

Osteoarthritis in Horses

OA is a common cause of lameness and poor performance in horses. Lameness, in general, has been estimated to account for 68% of the number of training days lost per year in a population of young Thoroughbred racehorses (Rossdale et al. 1985). Another study shows that OA was responsible for 54% of lame horses (Todhunter and Lust 1992).

An exact etiology of equine OA or its effective treatment has not been elucidated. Trauma has been suggested to be a common etiological factor in the occurrence of OA. This may be a single event trauma or more insidious damage caused by multiple repetitive traumatic insults. The latter, commonly called “use trauma”, implies that the traumatic damage is due to the normal, day-to-day activities, which may include athletic training and competition (Kidd et al. 2001). Recently, OA has been described in a herd of wild ponies (Cantley et al. 1999) and the authors suggest that equine OA can occur spontaneously and that development of OA in horses may be accelerated by the stresses of racing and training. The hypothesis that use trauma is the most common cause of OA is also supported by the increased incidence of OA in young horses used for athletic activity (Hoffman et al. 1984). A certain amount of joint loading is required in healthy joints to lubricate the joint and stimulate production of matrical proteins but excessive loading is unfavorable, suggesting that there is an injurious threshold of joint loading (Evans and Brown 1993).

Equine OA is most frequently manifested clinically as a slowly progressive lameness, which can often be bilateral. There may be joint pain, decreased range of motion, variable joint effusion, and inflammation, which is not systemic but commonly localized to the synovial membrane and joint capsule (Kidd et al. 2001). As a response to cytokines, such as IL-1, and other inflammatory mediators from chondrocytes in OA cartilage, the joint capsule and synovium increase their vascularity and begin to thicken. In addition, synovial cells in the swollen synovium release pro-inflammatory cytokines and mediators into the synovial fluid to hasten the cartilage matrix degradation. Commonly affected joints in OA horses

include metacarpophalangeal joints (most common), carpal joints, distal intertarsal and tarsometatarsal joints, and proximal interphalangeal joints.

Apoptosis

The term, “apoptosis”, was first used by Kerr et al. in 1972 to describe a specific form of cell death. Apoptosis is an ancient Greek word meaning the “falling off” of leaves from trees or petals from flowers. It refers to the particular morphology of physiological cell death, which has specific features of membrane blebs and apoptotic bodies separating from the apoptotic cells. The term apoptosis is also frequently referred to as programmed cell death implying that the cell death results from a precisely regulated activation of a series of preexisting factors in a death program that is encoded in the genome.

Apoptosis is not a newly described phenomenon. In 1858, Virchow described the progressive changes in the appearance of body tissues shortly after death. He described necrosis being where “the mortified cell is left in its external form” and “necrobiosis or shrinkage necrosis being where the cell vanishes and can no longer be seen in its previous form”. The necrobiosis, which he described, is what we recently call apoptosis (Afford and Randhawa 2000).

Apoptosis and Necrosis

Apoptosis is characterized morphologically by cell shrinkage, nuclear condensation, membrane blebbing, formation of apoptotic bodies, and phagocytosis by neighboring cells or phagocytic cells. Apoptosis occurs in embryogenesis and development when forming a body cavity by eliminating cells. In mature animals, apoptosis maintains the constancy of tissue mass as the counterpart of cell division (Saikumar et al. 1999). The tadpole’s tail disappears by apoptosis during metamorphosis, which is triggered by a surge of thyroid hormone in the blood stream (Kashiwagi et al. 1999). During vertebrate development, more neurons are produced than are needed, and apoptosis eliminates 20% to 80% of them. This is regulated by the limited amounts of nerve growth factor produced by other cells (Clarke et al. 1998).

Removal of cells injured by genetic defects, aging, disease, or exposure to noxious agents is accomplished by apoptosis (Saikumar et al. 1999). During ischemic conditions, such as myocardial infarction and stroke, cells die not only by necrosis but also apoptosis (Geng 1997). In the acquired immunodeficiency syndrome (AIDS), the human

immunodeficiency virus (HIV) causes the death of T-helper cells that are necessary to activate and prevent apoptotic death of cytotoxic T cells (Kalams and Walker 1998). Other pathological conditions that are related to apoptosis include autoimmune diseases, such as systemic lupus erythematosus and Hashimoto's thyroiditis, Parkinson's and Alzheimer's diseases, reticular degeneration, and B-cell lymphoma (Saikumar et al. 1999).

Apoptosis can be differentiated from the other form of cell death, termed necrosis. Necrosis occurs in response to injury by physical stimuli, toxins, or ischemia. Swelling of cells, disruption of membranes, and lysis of nuclear chromatin are prominent features of necrosis.

Confusingly, a mixed form of cell death simultaneously having apoptotic and necrotic morphology may be seen. This is the superimposition of "secondary necrosis" upon apoptosis caused by overlapping necrotic and apoptotic processes (Papassotiropoulos et al. 1996).

The fate of cell death whether apoptotic, necrotic, or secondary necrosis is determined by the intensity and duration of injurious damage as well as the level of cellular energy supply. Unlike necrosis, apoptosis requires cellular ATP to execute the process (Saikumar et al. 1998; Leist et al. 1999). Thus, cells injured by stressful stimuli may enter apoptotic process, but undergo necrosis secondarily when energy levels within cells decline.

Mechanisms of Apoptosis

Apoptosis was first characterized during genetic studies on the nematode worm, *Caenorhabditis elegans*. *C. elegans* development involves the activation of selective death genes that kill exactly 131 cells and leave 959 cells intact in the worm (Ellis and Horvitz 1986). Apoptosis consists of three successive stages: 1) commitment to death triggered by extracellular or intracellular signals; 2) execution of cell killing by activation of intracellular proteinases; and 3) removal of dead cells through engulfment of cell remnants by other cells, followed by digestion of the remnants within lysosomes of phagocytic cells (Saikumar et al. 1999).

1. Apoptotic Death Signals

Cellular decisions to initiate apoptotic programs are governed by either removal of survival signals or extracellular or intracellular death signals. Removal of adherent epithelial cells from extracellular matrix is a good example of removal of survival signals. Integrin

receptor-mediated signal transduction is required for the survival of anchorage-dependent cells (Ruoslahti and Reed 1994). Elimination of soluble growth factors, which are also important sources for survival signals, can trigger apoptosis (Feng et al. 1998).

There are some extracellular stimuli that can advance to apoptotic death. This process can be triggered by agents that can penetrate the cell directly and modulate the apoptotic cascade in the absence of specific cell surface receptors. Examples of such stimuli include heat shock/stress factors, free radicals, UV radiation, drugs, synthetic peptides, toxins, and lymphocytic granzymes (Afford and Randhawa 2000). Other mechanisms are dependent on expression of appropriate cell surface receptors.

The best-characterized receptor associated-apoptotic signaling pathway involves binding of proteins, such as tumor necrosis factor-alpha (TNF- α) and Fas ligand (FasL), to their corresponding surface receptors TNFR1 and Fas (APO-1 or CD95) (Magnusson and Vaux 1999). Fas and FasL are implicated in peripheral deletion of autoreactive T cells, activation-induced T cell death, and one of the two cytolytic pathways mediated by CD8⁺ cytolytic cells (Nagata 1997). Although FasL was initially thought to be lymphoid specific, studies have shown that FasL is constitutively expressed in a variety of nonlymphoid tissues including heart, pancreas, and articular cartilage (French and Tschopp 1996; Hashimoto et al. 1997). Fas is a glycosylated 45 kD transmembrane receptor that belongs to the TNF receptor superfamily, which is composed of at least 19 members (Smith et al. 1994).

Death receptors such as Fas and TNFR1 contain cytoplasmic domains (death domains) of approximately 80 amino acids that are essential for generating death signals (Hofmann and Tschopp 1995). After binding to their corresponding ligands, death receptors form homotrimeric complexes and recruit intracellular adapter proteins to the cell membrane. In the case of TNFR1, the adaptor protein is TNFR-associated death domain protein (TRADD), whereas Fas interacts with Fas-associated death domain protein (FADD). Binding of TRADD or FADD to the death domains causes the activation of procaspase-8, an initiator caspase, which sequentially activates execution caspases (Saikumar et al. 1999).

2. Activation of Caspases

Caspases (cysteine aspartyl-specific proteases) are intracellular cysteine proteinases that cleave their substrates at aspartic acid residues (Reed 2000). These proteinases are

present as inactive zymogens in essentially all animal cells, but can be triggered to active stages. In humans and mice, approximately 14 caspases have been identified and can be subgrouped into initiator caspases and execution caspases according to their functional specificities (Huppertz et al. 1999; Reed 2000). One of the functional differences between initiator caspases and execution caspases is that once the execution caspases are activated, the process of cell death cannot be reversed (Saikumar et al. 1999). Although most caspases are directly involved in cell apoptosis, a few are not, at least in mammals and higher eukaryotes. A group of caspases, including caspases-1, -4, and -5 in humans, is involved in processing of pro-inflammatory cytokines (Reed 2000).

Among the initiator caspases, caspase-8 and caspase-9 are the most studied. After the binding of peptides such as TNF- α or FasL, their receptors oligomerize and recruit adaptor proteins (FADD, TRADD) to form death-inducing signal complexes (DISC), causing the activation of the caspase-8. Caspase-8 cleaves Bid (a pro-apoptotic Bcl-2 protein), yielding a 15kD protein, which migrates to mitochondria and releases cytochrome c. Released cytochrome c activates caspase-9 by binding to the caspase-activating protein Apaf-1 (apoptotic protease activating factor-1). Consequential activation of caspase-3, a potent execution caspase, occurs by activated caspase-9 (Saikumar et al. 1999).

Initiator caspases are also responsible for early proteolytic events such as the cleavage of cytoskeletal and related proteins including vimentin, actin, and fodrin (a membrane associated cytoskeletal protein) (Huppertz et al. 1999). These early apoptotic events are believed to be responsible for the characteristic blebbing of the cell surface (McCarthy et al. 1997).

Important mammalian execution caspases are caspases-3, -6, and -7. Their activation leads to the degradation of a variety of proteins and to the activation of enzymes, e.g. nuclease. Therefore, the activation of these execution caspases is the hallmark of apoptosis (Huppertz et al. 1999). Selective inhibitors of caspase-3 inhibit apoptosis (Lee et al. 2000). Caspase-3 has been found to be activated in virtually every model of apoptosis (Porter and Janicke 1999). Natural substrates of caspase-3 include many proteins involved in cell maintenance and repair (Nicholson and Thornberry 1997). For example, oligonucleosome fragmentation (DNA laddering) is a characteristic feature of apoptosis and is mediated by

caspase-activated deoxyribonuclease (CAD), whose activation is effected by the caspase-3-mediated cleavage of the CAD inhibitor, ICAD (Enari et al. 1998).

Caspases-6 and -7 are other members of execution caspases (Lincz 1998). In some systems, caspase-6 was found to be activated prior to caspases-3 (Grossmann et al. 1998); in others caspase-8 activates caspase-3, which in turn activates caspase-7, leading finally to the activation of caspase-6 (Cohen 1997).

3. Bcl-2 Family Proteins

The mitochondria-dependent pathway for apoptosis is governed by Bcl-2 family proteins. There are both pro-apoptotic and anti-apoptotic Bcl-2 family proteins and many of these proteins physically bind each other, forming a complex of homo- and heterodimers (Adams and Cory 1998). The relative ratios of anti- and pro-apoptotic Bcl-2 family proteins are responsible for the fate of cells (Reed 2000). Bcl-2 was first discovered as a proto-oncogene in B cell lymphomas (Saikumar et al. 1999). It causes oncogenesis by suppressing apoptosis rather than by stimulating rapid cell division. Apoptosis inhibition by Bcl-2 over-expression occurs by growth factor withdrawal, glucocorticoid treatment, chemotherapeutic agents, gamma-radiation of thymocytes, and hypoxia of kidney cells (Saikumar et al. 1999).

In humans, there are approximately 20 members of Bcl-2 family genes that have been described to date. The genes that encode anti-apoptotic proteins include Bcl-2, Bcl-x_L, Mcl-1, Bfl-1(A1), Bcl-W, and Boo (Diva) and those that encode pro-apoptotic proteins are Bax, Bak, Bok (Mtd), Bad, Bid, Bim, Bik, Hrk, Bcl-X_S, APR (Noxa), p193, Bcl-G, Nip3, and Nix (BNIP) (Adams and Cory 1998; Saikumar et al. 1999; Reed 2000). Sequence comparisons on a majority of Bcl-2 family proteins have revealed up to four conserved areas, BH (Bcl-2 homology) domains: BH1, BH2, BH3, and BH4. The other subset of Bcl-2 family proteins commonly has only the BH3 domain. Those are Bad, Bik, Bim, Hrk, Bcl-G_S, p 193, and APR (Noxa); all of them are pro-apoptotic proteins and their apoptotic activity depends on dimerization with anti-apoptotic members such as Bcl-2 and Bcl-x_L to create a pore (Kelekar and Thompson 1998).

Many Bcl-2 family proteins are constitutively localized to the membranes of mitochondria. For example, Bcl-2 and Bcl-x_L have a group of hydrophobic C-terminal amino acids, the transmembrane domain, which anchors the proteins in the outer membrane of

mitochondria, while many pro-apoptotic proteins such as Bid, Bim, and Bad lack C-terminal transmembrane domains and normally exist in the cytosol but can be induced in mitochondrial membranes (Reed 2000). In the case of Bid, as activated caspase-8 cleaves the N-terminal 52 amino acids, the BH3 domain and the hydrophobic core of the protein are exposed (Schendel et al. 1999). Translocated, truncated Bid interacts with Bax and releases cytochrome c (Li et al. 1998). Bax, a normally cytosolic protein, translocates to mitochondria following exposure to various apoptotic stimuli (Saikumar et al. 1999). Bax is the only Bcl-2 family protein that has a C-terminal transmembrane domain but exists in the cytosol. In the outer membranes of mitochondria, Bax is thought to assume an active conformation and/or to interact with outer membrane proteins to form pores, releasing cytochrome c (Shimizu et al. 1999).

Bcl-2 and Bcl-x_L are the representative anti-apoptotic Bcl-2 family proteins and the most potent inhibitors of cell death yet discovered (Saikumar et al. 1999). They are located in the outer membranes of mitochondria and inhibit apoptosis by preventing mitochondrial permeabilization and the release of cytochrome c (Yang et al. 1997). In addition to cytochrome c, anti-apoptotic Bcl-2 family proteins control the release of other pro-apoptotic proteins from the mitochondria. These proteins include AIF (apoptosis inducing factor), which induces apoptosis via a caspase-independent mechanism, and Smac/Diablo, an inhibitor of IAPs (inhibitors of apoptosis proteins; Reed 2000).

4. Inhibitors of Apoptosis Proteins

There are endogenous inhibitors of apoptosis other than anti-apoptotic Bcl-2 family proteins. A structurally distinct group of proteins that block apoptosis has been identified in the cytosol and referred as inhibitors of apoptosis proteins (IAPs) (Saikumar et al. 1999). IAPs can function as “suicide substrates” for caspases by neutralizing caspase-mediated cleavage (Patston et al. 1991). Expression of survivin, a human IAP, correlates with decreased apoptosis and oncogenic transformation (Ambrosini et al. 1997).

5. Protein Degradation and DNA Fragmentation

Early proteolytic events, which are mainly associated with activated initiator caspases, include cleavage of fodrin (an abundant membrane-associated cytoskeletal protein), vimentin, and actin (Hupperz et al. 1999). The cleavage of cytoskeletal proteins and modification of

cytoplasmic proteins like myosin result in shrinkage of the cell and blebbing of the cell surface (Mills et al. 1998). The flip of phosphatidylserine from the inner to the outer leaflet of the plasma membrane of cells is another early apoptosis event (Martin et al. 1995). In normal conditions, aminophospholipids such as phosphatidylserine or phosphatidylethanolamine are confined to the inner leaflet of the plasma membrane while neutral phospholipids such as phosphatidylcholine are in the outer leaflet. This composition is maintained by the ATP-dependent aminophospholipid translocase. In the early stage of apoptosis, activated initiator caspases inhibit the translocase activity as well as activate translocating proteins (scramblases or floppases), resulting in the accumulation of phosphatidylserine in the outer leaflet of plasma membrane (Hupperz et al. 1999). The translocated phosphatidylserines serve as a recognition signal of apoptotic cells for phagocytes (Savill 1998).

In the later stage of apoptosis, activated execution caspases cleave a variety of cytoplasmic and membrane proteins including α - and β -catenin and focal adhesion kinase by caspases-3 and -6, and intermediate filament cytokeratin 18 by caspases-3, -6, and -7 (Hupperz et al. 1999). The principle targets of the execution caspases, however, are nuclear proteins including nuclear envelope proteins: lamin A, B, and C, poly-(ADP-ribose)polymerase (PARP), and endonucleases. Lamins are the major structural proteins of the nuclear envelope and generally are cleaved by caspase-6 (Hupperz et al. 1999). PARP is a DNA repair enzyme and inhibits $\text{Ca}^{2+}/\text{Mg}^{2+}$ -dependent endonucleases, which cleave DNA during apoptosis (Tanaka et al. 1984). Therefore, the cleavage by caspases results in reduced DNA repair and increased chance of DNA damage. In addition, execution caspases activate endonucleases, which are responsible for a highly characteristic pattern of DNA fragmentation, producing typical DNA ladder in agarose gel.

6. Phagocytic Recognition

Interactions between apoptotic cells (apoptotic bodies) and phagocytes are not fully understood, but a series of molecules seem to be important in the apoptotic cells. These molecules include phosphatidylserin, anionic phospholipids in the outer leaflet of the plasma membrane (Savill 1997), and intercellular adhesion molecule 3 (ICAM 3; Moffatt et al. 1999). Key recognition molecules on the phagocytes include CD14 (which partners ICAM 3), CD36, and vitronectin receptor ($\alpha\text{v}\beta 3$ integrin). Both CD36 and vitronectin receptor bind

a bridging molecule, thrombospondin, which seems likely to link with phosphatidylserine on the apoptotic cell membrane (Afford and Randhawa 2000).

CHAPTER II: CHONDROCYTE APOPTOSIS IN EQUINE OSTEOARTHRITIS

Introduction

Joint pain and loss of mobility caused by osteoarthritis (OA) are common causes of poor performance and early retirement in equine athletes (Todhunter and Lust 1992). Traumatic injury is believed to be a common cause of OA. It may be single event trauma, arising from a clearly definable injury to joint structures, or more insidious, repetitive, traumatic insults. Development of OA in horses is often associated with the stresses of racing and training (Cantley et al 1999), rendering the supports to the idea that mechanical stress is the major cause of OA.

Loss of articular cartilage and fibrillation are the most striking features of OA within the cartilage. This fact has lead most arthritis-related research to study the changes within extracellular matrix. Little attention has been given to the role of chondrocyte survival or death. Recent studies using electron microscopy, flow cytometry, and DNA fragmentation assay (terminal deoxynucleotidyl transferase-mediated dUTP nick-end labeling; TUNEL assay) have shown that apoptosis is the major pathway of chondrocyte death in the human articular cartilage of OA (Blanco et al. 1998, Hashimoto et al. 1998a, Hashimoto et al. 1998b, Hashimoto et al. 1998c, Lotz et al. 1999). Recently, chondrocyte apoptosis has received more attention in pathogenesis of OA because chondrocytes are the only cells existing within and maintaining the extracellular matrix in the articular cartilage.

Nitric oxide (NO) has been implicated as an important biological mediator of OA. NO production from chondrocytes is significantly higher in OA cartilage compared with that in the control, and directly correlates with the severity of OA (Hashimto et al. 1998c; Spreng et al. 2000). The major source of endogenous NO in chondrocyte is inducible nitric oxide synthase (iNOS). Experimental treatment with selective inhibitors against iNOS has significantly reduced the progression of OA *in vivo* (Pelletier et al. 1998; Pelletier et al. 2000). NO reacts with the superoxide radical to form peroxynitrite. In tissues or biologic fluids, peroxynitrite leads to the nitration of aromatic amino acid residues, and the presence of such nitration can be used as a marker of peroxylnitrite-mediated NO action *in vivo* (Beckman 1994).

No studies have been done on chondrocyte apoptosis in equine osteoarthritis. The present study investigated chondrocyte apoptosis in the articular cartilages from horses with OA and examined the relationship between chondrocyte apoptosis and cartilage degeneration. In addition, a possible link between chondrocyte apoptosis and endogenous NO production was examined.

Materials and Methods

Equine Articular Cartilage

Cartilage was obtained from articular surfaces of the distal metacarpal or metatarsal bones from 8 horses (age range from 2 to 7 years): 5 horses with OA and 3 normal horses. The horses had been submitted for either postmortem examination or for other non-joint-related research. Full-thickness slices of cartilage specimens were harvested within 3 hours of death.

Histopathologic Evaluation

The cartilage specimens were fixed in 10% neutral buffered formalin, processed by standard procedures, embedded in paraffin, sectioned (4 μ m), and stained with hematoxylin and eosin for histopathologic evaluation. The histopathologic evaluation criteria originally proposed by van der Sluijs et al. (1992) were used with slight modification (Table 2.1). Since the calcified layer of articular cartilage and underlying subchondral bone were not included in the cartilage specimens, one of the evaluation criteria, “Tidemark integrity”, was not considered. Also, when fissures reached to the deep layer of articular cartilage instead of calcified layer as originally proposed, the damage was considered to be enough to score 5. The severity of OA was represented by a combined total score (0-9) assessing structural damages (0-6) and cellular abnormalities (0-3).

In situ Detection of Chondrocyte Apoptosis

Chondrocyte apoptosis was identified with an immunohistochemical method (TUNEL method) using the ApopTag[®] peroxide *In Situ* Apoptosis Detection Kit (Intergen, Purchase, NY). Tissue sections were pretreated with 3% hydrogen peroxide for 5 minutes and digested with proteinase K (DAKO[®] Proteinase K Ready-to-Use; DAKO, Carpinteria, CA) for 10 minutes at room temperature. DNA fragments were end-labeled with digoxigenin-labeled dUTP using terminal transferase, and were detected with peroxidase-conjugated

antidigoxigenin antibody. Diaminobenzidine tetrahydrochloride (DAB) was used as the chromogen and the signal was amplified with additional incubation in 0.5% copper sulfate solution for 5 minutes at the room temperature. For counter-staining, 0.5% methyl green in 0.1M sodium acetate for 10 min was applied.

Table 2.1. Histopathologic criteria for osteoarthritis

Criteria	Score
Structure	
Normal	0
Irregular surface, including fissures into the middle layer	1
Pannus	2
Superficial cartilage layers absent	3
Slight disorganization (cellular rows absent, some small superficial clusters)	4
Fissures into deep cartilage layer	5
Disorganization (chaotic structure, clusters, osteoclast activity)	6
Cellular abnormalities	
Normal	0
Hypercellularity, including small superficial clusters	1
Clusters (cloning)	2
Hypocellularity	3
Total	0-9

Immunohistochemistry for Nitrotyrosine

The tissue sections were pretreated with proteinase K (DAKO® Proteinase K Ready-to-Use; DAKO, Carpinteria, CA) for 10 minutes at the room temperature and then with 3% hydrogen peroxide for 5 minute at the room temperature. The distribution of nitrotyrosine was determined with the avidin-biotin-peroxidase (ABC) method using VECTASTAIN® Elite ABC-Peroxidase Kit (Vector Laboratories, Burlingame, CA). Rabbit polyclonal antibody to nitrotyrosine (Upstate Biotechnology, Lake Placid, NY) was used as the primary antibody.

The negative control consisted of nonimmune rabbit serum as a substitute for the primary antibody.

Data Analysis

The Kruskal-Wallis non-parametric ANOVA was used to evaluate statistical differences in histopathologic scores and percentage of chondrocyte apoptosis between normal and OA cartilages. The correlation between histopathologic grades and chondrocyte apoptosis was analyzed with Spearman rank correlation test. Statistical significance was established at 95% confidence interval ($p < 0.05$).

Results

Histopathologic Evaluation

All control horses had grossly normal articular cartilage surfaces, while the OA horses had rough, often slightly yellow and dull, fibrillated articular surfaces. All cartilage specimens from normal horses had no or minimal microscopic changes with a score of 0 or 1 (median = 1). The only microscopic change observed was mild articular surface irregularity, but no cellular abnormalities were noted (Figure 2.1). OA cartilages, however, showed a wide range of structural alterations as well as cellular abnormalities. The structural changes ranged from irregular surface to fibrillation into deep cartilage layers but none of the OA cartilages showed chaotic structural disorganization. The cellular abnormalities included multifocal areas of hypercellularity in the superficial layers and clustering (cloning) of chondrocytes in the fibrillated articular surface as well as along the fissures in the deep layers (Figure 2.2). OA cartilages had a score of 6 or 7 (median = 7). The histopathologic scores of OA cartilages (6.6 ± 0.55 ; mean \pm SD) were significantly higher than those from the normal cartilages (0.67 ± 0.58) ($p = 0.004$).

Chondrocyte Apoptosis

The percentage of apoptotic chondrocytes in the OA cartilage was significantly higher than that in the normal articular cartilage ($p=0.008$) (Table 2.2). Because the cartilage specimens collected from the articular joints did not consistently contain the deep layer and chondrocyte apoptosis mainly occurred in the superficial and middle layers, apoptotic chondrocytes were counted only in the superficial and middle layers. The percentage of

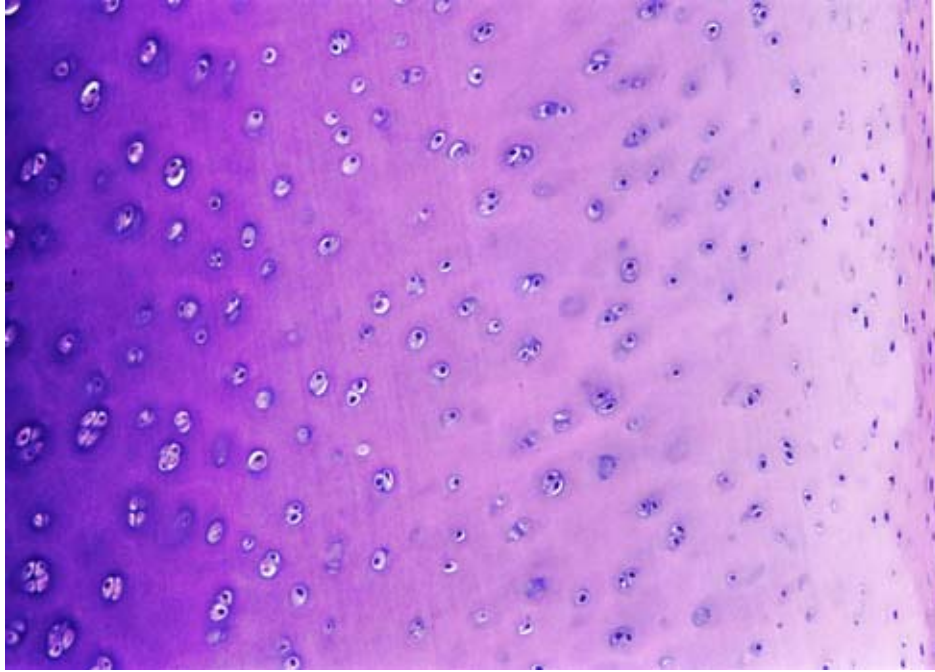

Figure 2.1. Equine normal articular cartilage. No microscopic abnormalities are noted.

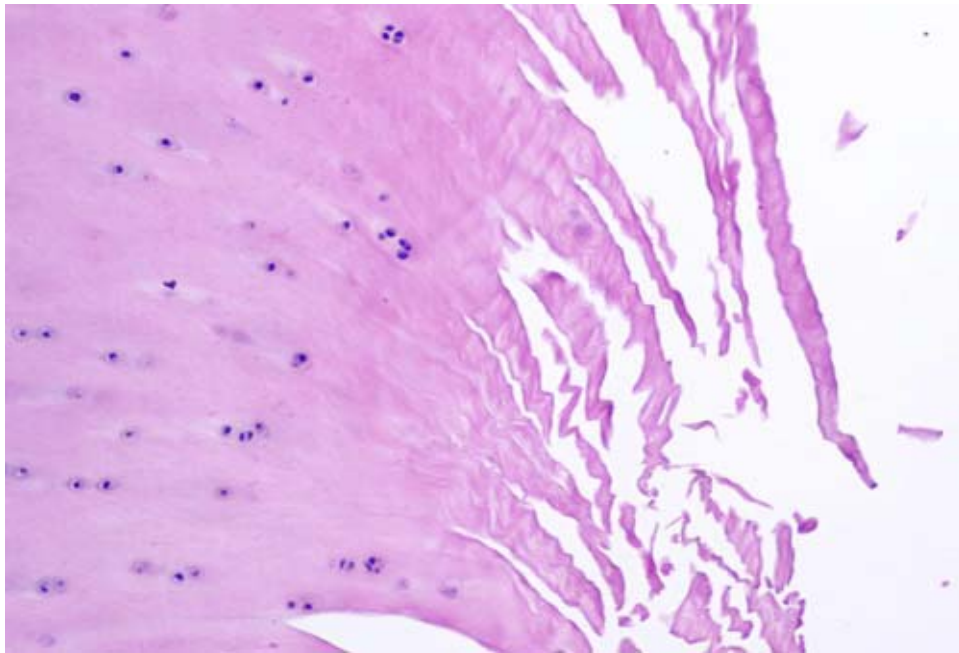

Figure 2.2. Articular cartilage from an osteoarthritic horse. Note the severe fibrillation of the articular surface and chondrocyte clustering (cloning).

apoptotic chondrocytes in the normal cartilages (Figure 2.3) ranged from 2 to 5.3 % (3.3 ± 1.7 %; mean \pm SD). In contrast, the OA cartilages (Figures 2.4 and 2.5) contained frequent apoptotic chondrocytes, ranging from 20.8 to 39.7 % ($32.6 \pm 9.1\%$). Because the superficial layers of all OA cartilages were diffusely effaced, especially in the areas of fibrillation, most counted chondrocytes were located in the middle layer. For detailed analysis, apoptotic chondrocytes were counted separately in the lesional (fibrillation) and in non-lesional areas of OA cartilage specimens. Although statistically not significant, the percentage of apoptotic chondrocytes in the lesional areas (35.8 ± 9.6 %) was higher than the non-lesional areas (26.9 ± 4.4 %) ($p = 0.07$).

Table 2.2. Percentage of apoptotic cells in equine articular cartilage (mean \pm SD)

Character of cartilage		Percentage of apoptotic cells
Normal cartilage (n=3)		3.3 ± 1.7
OA cartilage (n=5)	Overall	32.6 ± 9.1^a
	Lesion	35.8 ± 9.6^b
	Non-lesion	26.9 ± 4.4

^a $p= 0.008$; Kruskal-Wallis ANOVA, vs. normal cartilage

^b $p=0.07$; Kruskal-Wallis ANOVA, vs. non-lesional OA cartilage

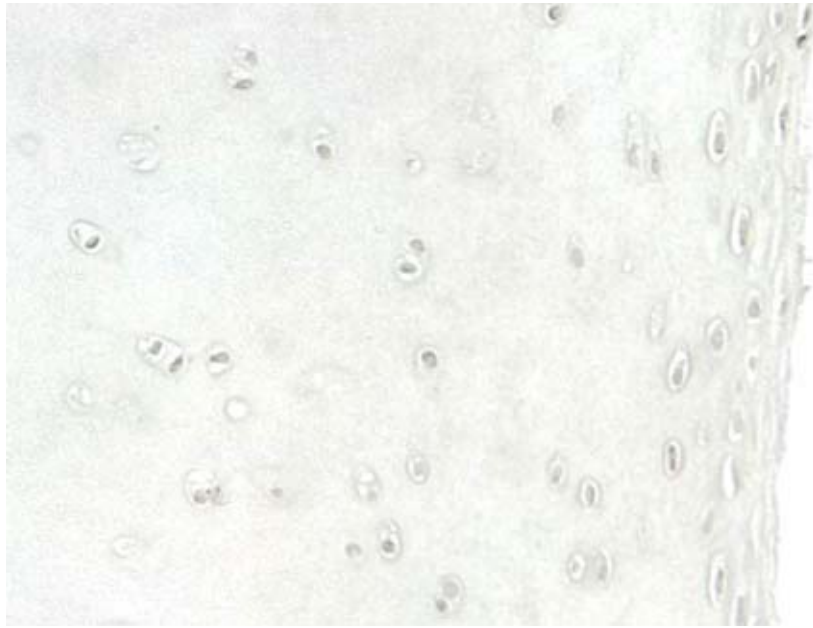

Figure 2.3. TUNEL staining for detecting DNA fragmentation in equine normal articular cartilage. No cells with positive immunoreactivity are noted.

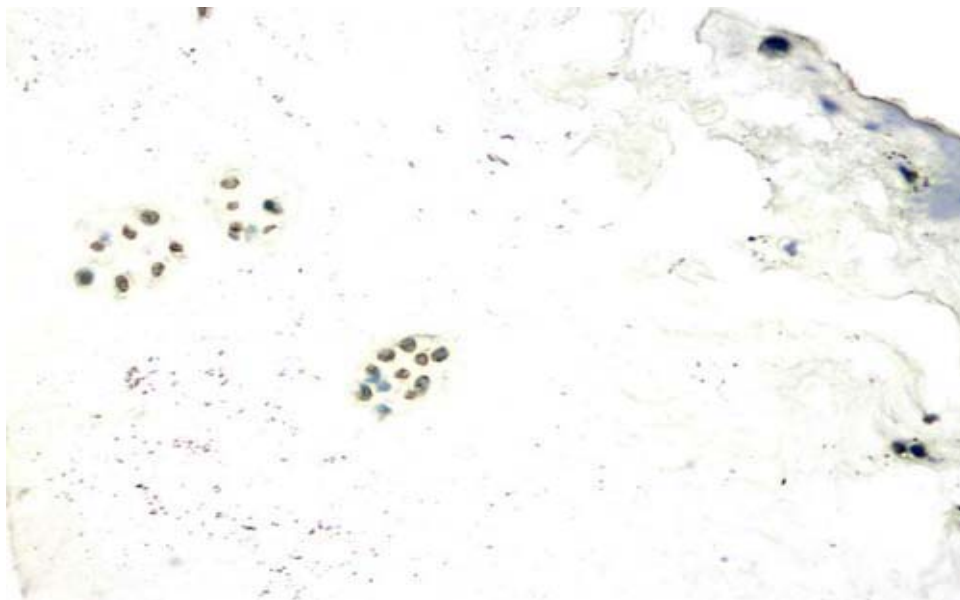

Figure 2.4. TUNEL staining for detecting DNA fragmentation in equine osteoarthritic articular cartilage. Note positive immunoreactivity in the clusters of chondrocytes in the areas of fibrillation.

Correlation between Histopathologic Grade and Chondrocyte Apoptosis

There was a significant correlation between histopathologic grade and apoptotic chondrocyte numbers in OA cartilage ($p < 0.001$) (Figure 2.5).

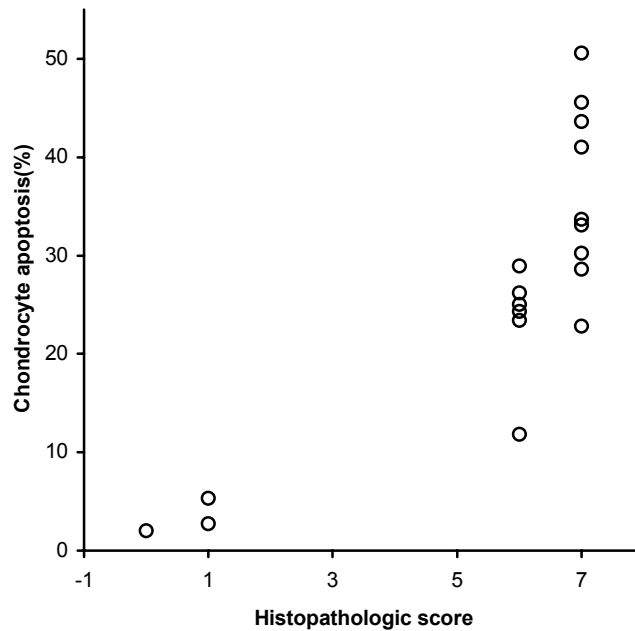

Figure 2.5. Correlation between histopathologic grade and chondrocyte apoptosis ($p < 0.001$).

Detection of Nitrotyrosine

The normal articular cartilages showed mild immunostaining limited to the chondrocytic cytoplasm and the pericellular matrix immediately adjacent to the chondrocytes in the superficial and upper middle layers (Figure 2.6). The OA cartilages exhibited intensely stained chondrocyte cytoplasm and cartilage matrix in a diffuse pattern. The positive immunoreactivity was present not only in the superficial and middle layers but also in the deep layer in the areas of fibrillation (Figure 2.7). The distribution of intense nitrotyrosine immunoreactivity in the OA cartilages paralleled that of chondrocyte apoptosis.

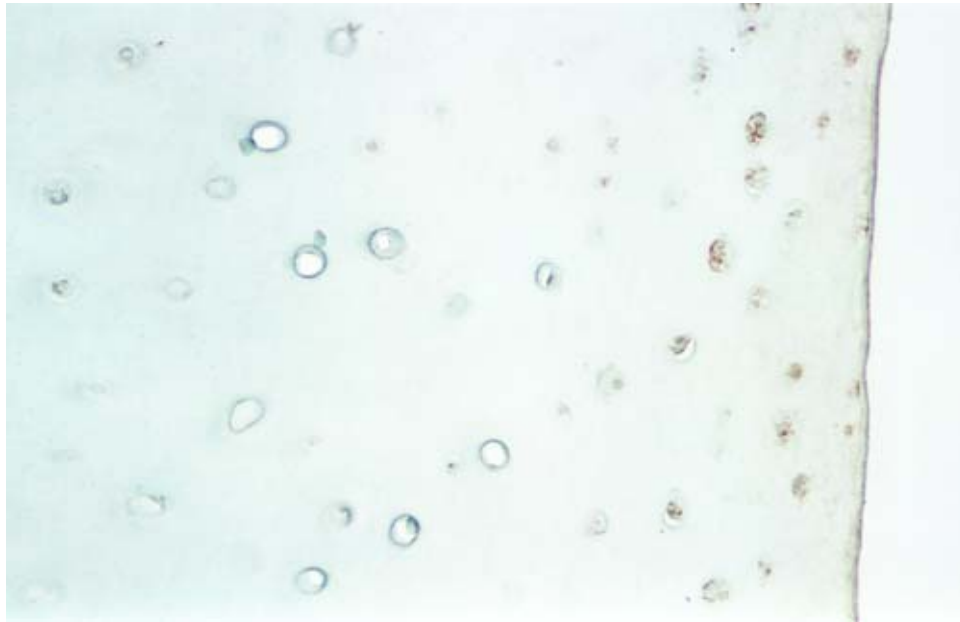

Figure 2.6. Immunohistochemistry for nitrotyrosine in equine normal articular cartilage. Positive immunoreactivity is limited to the chondrocytic cytoplasm and the pericellular matrix in the superficial and upper middle layers.

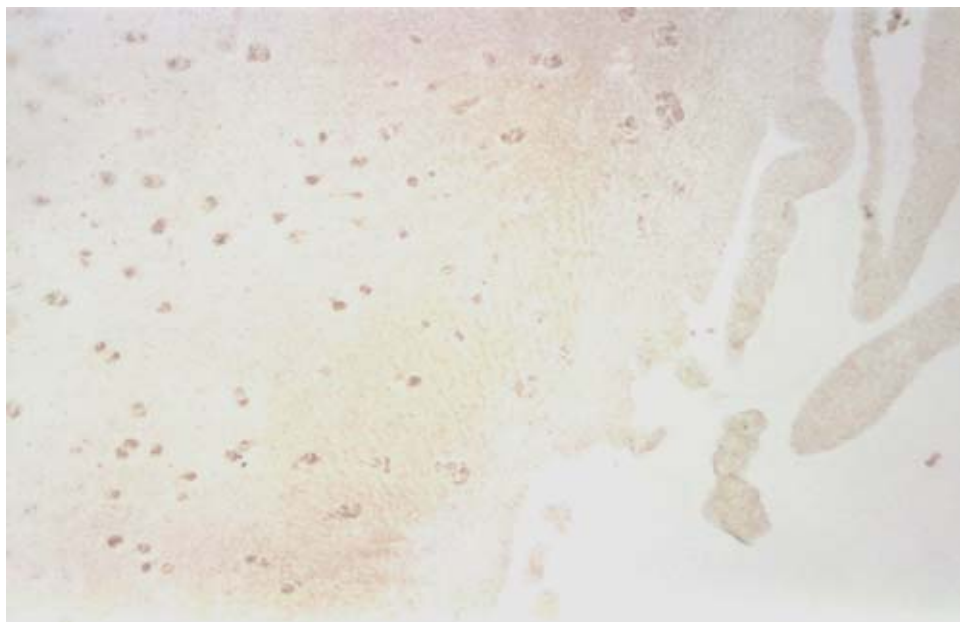

Figure 2.7. Immunohistochemistry for nitrotyrosine in equine osteoarthritic articular cartilage. Note intensely positive immunoreactivity of the chondrocytes as well as cartilage matrix in a diffuse pattern in the areas of fibrillation.

Discussion

Osteoarthritis is the most common disease of equine joints. Musculoskeletal disorders including OA are leading causes of morbidity in the athletic horses. It has been reported that 84.6% of injuries in the racehorses were related to the musculoskeletal system (Johnson 1991). Approximately 90% of those injuries were in forelimbs, frequently involving metacarpophalangeal (fetlock) and carpal joints (Rossdale et al. 1985). These injuries are considered to be related to the stresses resulting from excessive joint motion and excursion due to uneven ground, excessive training, immaturity, poor conformation, or improper shoeing (McIlwraith and Trotter 1996). It is believed that initial cartilage damage caused by mechanical trauma leads to progressive cartilage deterioration.

Chondrocyte apoptosis in OA cartilage has been reported in dogs and humans (Blanco et al. 1998; Hashimoto et al. 1998a; Hashimoto et al. 1998c; Pelletier et al. 1998; Kim et al. 2000). Human OA is age-related and the pathologic changes include decreases in chondrocyte cellularity in the cartilage and increases in empty lacunae. Chondrocyte apoptosis is considered to be one of the major causes of these age-related pathologic changes and is correlated with incidence of osteoarthritis (reviewed by Hashimoto et al. 1998c). Chondrocytic death by means of apoptosis has been reported in normal human cartilage and even in young people (Blanco et al. 1998; Hashimoto et al. 1998a; Kim et al. 2000). The pathogenesis of the age-related apoptosis is not fully understood. Recently, Chen et al. (2001) reported that chondrocyte apoptosis was observed in mechanical impact-damaged articular cartilage. It is possible that the increased apoptosis in the aged population may result from continuous mechanical stress on the articular joints during their lifespan. As an extension of this hypothesis, OA in young horses subjected to intense training could be, at least in part, directly associated with chondrocytic apoptosis initially caused by mechanical stresses.

In this study, we found that the number of apoptotic chondrocytes in OA cartilage was significantly higher than that in normal cartilage in horses. This observation is similar to the findings in human OA and in experimentally induced canine OA (Blanco et al. 1998; Hashimoto et al. 1998a; Hashimoto et al. 1998c; Pelletier et al. 1998; Kim et al. 2000). Kim et al. (2000) reported that within the same human OA cartilage, apoptotic chondrocytes were

noted more frequently in the lesional area than in the non-lesional area. A similar result was also obtained from the equine articular cartilages with OA in the present study.

Our investigation showed that chondrocyte apoptosis and degradation of articular cartilage were closely correlated. High incidence of chondrocyte apoptosis occurred in the severely degraded cartilage matrix. Whether chondrocyte apoptosis is a cause of or the result of cartilage breakdown is one of the pivotal questions in OA pathogenesis. Degradation of extracellular matrix could contribute to the loss of a survival signal for chondrocytes. Also, biological mediators, such as NO, cytokines, or proteinases (e.g. matrix metalloproteinases), from chondrocytes themselves or from other damaged chondrocytes, could directly or indirectly trigger apoptosis. Alternatively, chondrocyte apoptosis could cause the matrix degradation because chondrocytes are the only cells that exist in the cartilage and that maintain the extracellular matrix.

Excessive production of NO has been linked to cartilage catabolism (Hauselmann et al. 1998; Pelletier et al. 1998; Spreng et al. 2000) and chondrocyte apoptosis (Hashimoto et al. 1998c; Blanco et al. 1998; Hashimoto et al. 1999). We indirectly demonstrated NO produced by equine chondrocytes with polyclonal antibody to nitrotyrosine. Equine OA articular cartilage had more intense and diffuse positive immunoreactivity than the normal cartilage. In addition, strong positive reactivity was observed in the areas of degraded extracellular matrix, where frequent chondrocyte apoptosis was noted. In the marginal areas of fibrillation, the strong immunoreactivity corresponded with the high percentage of chondrocyte apoptosis as well.

The topographical distribution of matrix degradation, chondrocyte apoptosis, and NO production were almost completely overlapping in the equine OA articular cartilage, suggesting that these pathological phenomena are closely interrelated.

CHAPTER III: CYCLIC HYDROSTATIC PRESSURE INDUCES EQUINE CHONDROCYTE APOPTOSIS

Introduction

Decreased cellularity of chondrocytes is one of the characteristic features of osteoarthritis (OA) (Stockwell 1971, Lust and Summers 1981, Buckwalter and Mankin 1998). Recent studies strongly suggest that the loss of cellularity in the articular cartilage with OA is due to *in situ* chondrocyte apoptosis (Blanco et al. 1998, Hashimoto et al. 1998a, Kim et al. 2000). Preservation of cell viability in articular cartilage is essential to matrix metabolism, tissue repair, and the prevention of OA, because the chondrocyte is the only cell that exists in articular cartilage.

Articular cartilage is a load-bearing tissue and mechanical stress is believed to be a major factor of OA (Burton-Wurster et al. 1993, Lee et al. 1998, Steinmeyer et al. 1999a, Steinmeyer and Ackermann 1999b). OA can be categorized into two groups based on the etiology (Buckwalter and Mankin 1998). The primary OA is the most common OA in human and is often idiopathic. The secondary OA results from previous trauma or infection. Some investigators have suggested that the primary OA may also result from insidious joint injury (Kraus 1997, Buckwalter and Mankin, 1998).

In vivo OA experiments have demonstrated that the mechanical stress is responsible for chondrocyte apoptosis, the degree of which is closely correlated with matrix degeneration (Hashimoto et al. 1998c; Pelletier et al. 1998). Recently, *in vitro* studies have shown that a repetitive high impact mechanical loading on bovine articular cartilage explants induces chondrocyte apoptosis, and the number of apoptotic cells was correlated with the frequency, strength, and duration of applied mechanical pressure (Loening et al 2000, Chen et al 2001, Clements et al 2001). Loening and colleagues (2000) reported that chondrocyte apoptosis occurred without any matrix alteration after applying mechanical pressure on the cartilage explants, suggesting that chondrocyte apoptosis may be one of the earliest responses to the cartilage damage, and may precede and be the cause of matrix degradation.

A few *in vitro* studies using chondrocytes have been carried out on mechanical stress-related chondrocyte metabolism (Das et al. 1997; Lee et al. 1998a; Hutton et al. 1999), but

there have been no *in vitro* studies focused on chondrocyte apoptosis using chondrocytes under a cyclic high pressure.

The present *in vitro* experiment using equine chondrocytes in a novel pressure loading system demonstrated that cyclic hydrostatic high pressure directly induces chondrocyte apoptosis.

Materials and Methods

Equine Chondrocyte Isolation

Cartilage was obtained from articular surfaces of the distal metacarpal or metatarsal bones from 4 young horses (2 to 4 years old). The articular cartilage was grossly normal and the horses had no history of joint-related disease. The horses had been submitted for either postmortem examination or for other non-joint-related research. The cartilage specimens were collected within 3 hours of death. The joints were aseptically disarticulated and, with a scalpel blade, the superficial and deep layers of articular cartilages of metacarpal or metatarsal bones were separately harvested and placed in chilled PBS (pH 7.4) in petri dishes. The collected cartilage slivers were finely minced into 1mm or less pieces and incubated in Ham's F12/DMEM medium (Life Technologies, Grand island, NY) containing filter-sterilized collagenase II (final concentration of 3mg/ml; Worthington Biochemical Corporation, Lakewood, NJ) overnight in an incubator (37C, 5% CO₂, in a humidified atmosphere).

Construction of Alginate Beads

The remaining small fragments of cartilage were removed by gently and slowly passing the chondrocyte suspension through layers of autoclaved gauzes. The filtered cell suspension was centrifuged at 500x g for 10 minutes and the supernatant was discarded. The pelleted cells were washed twice more with sterile saline. A small amount (20 µl) of the cell suspension aliquot was collected and the total number of the cells was estimated by using a hemocytometer and cell viability was examined after staining with trypan blue. The rinsed chondrocytes were suspended in saline containing 1.2% (v/v) alginic acid (sodium salt; Sigma, St. Louis, MO) to yield a final concentration of 1.5×10^6 cells/ml. By using a syringe, the cell suspension was slowly expressed through a 22-gauge needle into a 102 mM CaCl₂ solution in 6-well cell culture plates, producing polymerized, regularly-sized, 3 dimensional constructs, "beads". After polymerization in the CaCl₂ solution for 10 minutes, the

chondrocyte-laden beads were rinsed with sterile saline 3 times, and with Ham's F12/DMEM twice, and incubated in the complete Ham's F12/DMEM medium including antibiotics and 10% fetal bovine serum (Life Technology, Grand island, NY) until the pressure loading experiment (within 7 days). The medium was replaced every two days.

Application of Hydrostatic Pressure

The pressure loading system consisted of two HPLC glass columns, an isocratic HPLC pump, and a metering valve (Figure 3.1). Superficial and deep layer chondrocytes embedded in alginate bead constructs were separately installed in the HPLC glass columns (AP glass column; Waters, Milford, MA) that were connected with an isocratic HPLC pump, and then pressurized at $1,000 \pm 100$ psi (approximately 6.8 ± 0.6 MPa). The pressure protocol consisted of repeated, 15 minute each on-off cycles for 12 hours. The peak pressure was reached within one minute in each cycle. The complete cell culture medium in the system was continuously recirculated throughout the experimental period. The chondrocyte-loaded HPLC columns and the complete culture medium were placed in a cell culture incubator at 37 °C in a humidified atmosphere with 5% CO₂. The pressure was carefully controlled with a metering valve (Hoke Fine Metering Valve; Alltech, Deerfield, IL) at a flow rate of 1.5 ± 0.2 ml/min. The culture medium continuously flowed in the system throughout the experimental period, even during off-cycles. For the controls, cell culture dishes containing chondrocytes from superficial and deep layers were placed next to the glass columns in the incubator. After being pressurized, the chondrocyte-laden alginate bead constructs were collected from the HPLC columns and placed in the incubator for 36 hours.

Immunocytochemistry for Chondrocyte Apoptosis

The chondrocytes were isolated from the dissolved alginate beads by treating with EDTA (final concentration of 25 mM for 10 minutes) and washed twice with saline. Numbers of isolated chondrocytes in each group were counted with a hemocytometer. Approximately 5×10^4 cells from each group were adhered to a glass slide by cytospin, fixed in chilled 1% paraformaldehyde for 10 minutes, air-dried, and stored at -70C for later use (within 2 days). Chondrocyte apoptosis was identified with an immunocytochemical method (TUNEL) using the ApopTag[®] peroxide *In Situ* Apoptosis Detection Kit (Intergen, Purchase, NY).

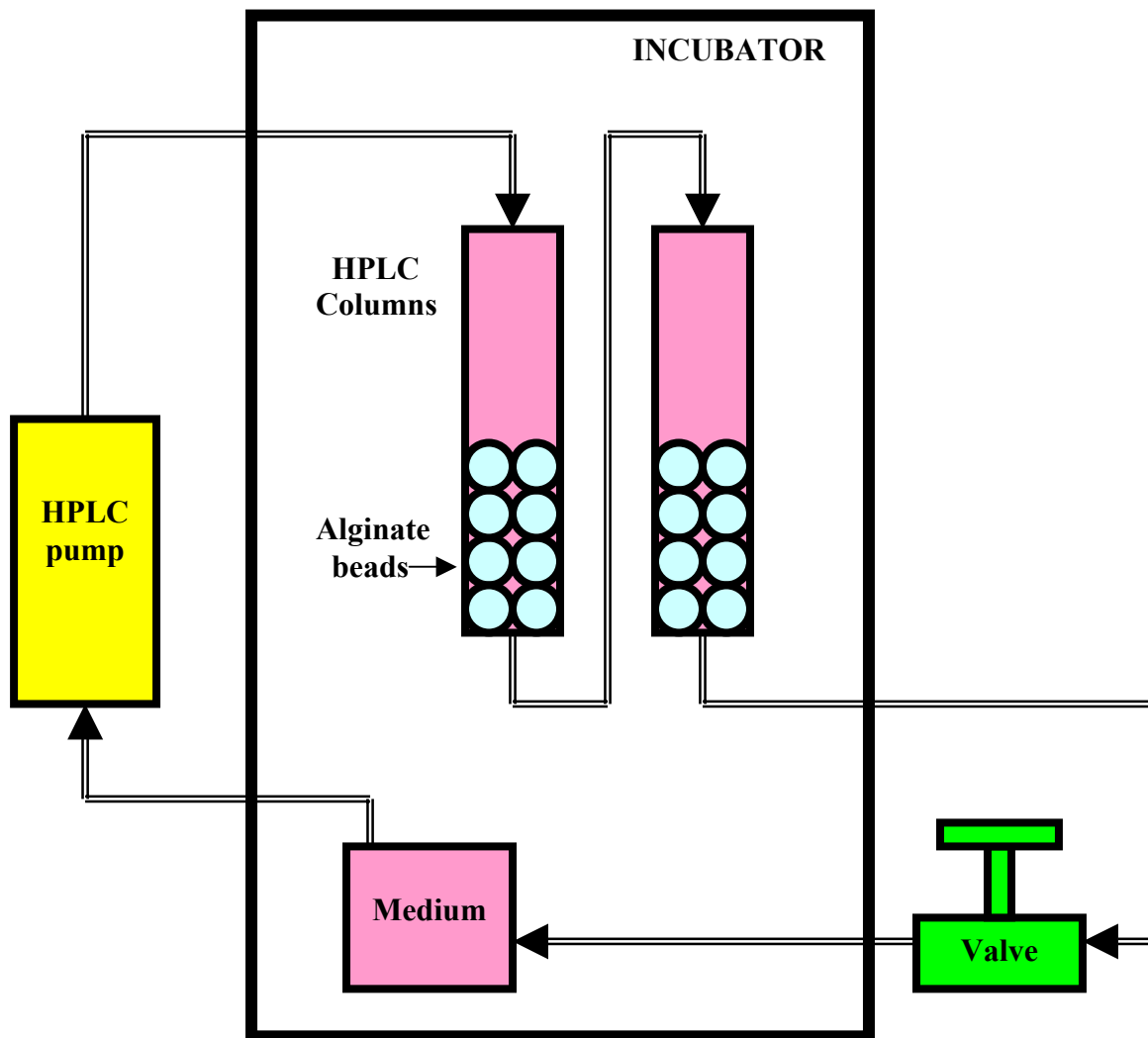

Figure 3.1. Hydrostatic pressure loading system. The system was composed of two HPLC glass columns containing chondrocyte-seeded alginate beads, an isocratic HPLC pump, and a metering valve. The chondrocytes were pressurized at $1,000 \pm 100$ psi (approximately 6.8 ± 0.6 MPa). The pressure protocol consisted of repeated, 15 minute each on-off cycles for 12 hours. The pressure was controlled by the metering valve and flow rate of cell culture medium (1.5 ± 0.2 ml/min) by the pump.

The chondrocytes on the glass slides were pretreated with 3% hydrogen peroxide for 5 minutes followed by 0.5% Triton X-100 for 10 minutes. DNA fragments were labeled with digoxigenin-labeled dUTP using terminal transferase, and were detected with peroxidase-conjugated antidigoxigenin antibody. Diaminobenzidine tetrahydrochloride (DAB; Sigma, St. Louis, MO) was used as the chromogen for detection and the signal was amplified with additional incubation in 0.5% copper sulfate solution for 5 minutes at the room temperature. For counter-staining, 0.5% methyl green in 0.1M sodium acetate for 10 minutes was applied.

Quantification of Chondrocyte Apoptosis and Statistical Analysis

Total numbers of chondrocytes (approximately 1,000 cells per slide) were counted in five, randomly selected, 400 X microscopic fields per slide with a digital image analyzing system (Image Pro[®] Plus, Media Cybernetics). Positively stained cells within these fields were counted manually. The cells were considered positive when their nuclei were stained or completely surrounded by the chromogen. The SAS statistical package (GLM procedure) was used to analyze the data. The chondrocyte apoptosis data and the data of relative increase ratios of control and treatment groups were normalized by log transformation. The log-transformed data were analyzed by an analysis of variance in a Randomized Block Design. For chondrocyte apoptosis analysis, the blocking factor was horse. The pressure-loading treatment and cartilage layer served as effects in the model and treatment*cartilage layer were examined for interactions. For analysis on the apoptosis increase ratio, the blocking factor was horse and the main effect was cartilage layer in the model. Pairwise comparisons were conducted with the LSMEANS option to obtain t-tests. All comparisons were considered significant at $p \leq 0.05$.

Results

Chondrocyte apoptosis occurred more frequently in the pressure-loaded chondrocytes of equine articular cartilage compared with the control ($p < 0.001$) (Table 2.1) (Figures 2.2 - 2.5). Significantly higher percentages of apoptosis occurred in the pressure-loaded chondrocytes of both the superficial and deep layers than in the corresponding control groups. Within the control groups, chondrocytes from the deep layers showed greater apoptosis than those from the superficial layers ($p=0.003$). The cyclic hydrostatic pressure induced more

apoptosis in the chondrocytes from the superficial layers than those from the deep layers (p<0.001) (Table 2.2).

Table 3.1. Apoptosis of pressure-loaded and control chondrocytes isolated from superficial and deep layers of equine articular cartilage (mean \pm SD)

Horse	Percentage of apoptotic chondrocytes			
	Pressure loaded ^a		Control	
	PS ^b (n=5)	PD ^c (n=5)	CS (n=5)	CD ^d (n=5)
1	3.49 \pm 0.72	4.74 \pm 1.78	0.80 \pm 0.39	2.54 \pm 1.02
2	3.38 \pm 1.26	4.19 \pm 1.65	1.82 \pm 1.37	2.82 \pm 1.15
3	3.33 \pm 0.77	6.18 \pm 1.17	0.97 \pm 0.93	1.44 \pm 1.50
4	9.08 \pm 2.72	7.54 \pm 2.91	1.87 \pm 1.11	2.10 \pm 0.72

PS: Pressure-loaded chondrocytes from superficial layer

PD: Pressure-loaded chondrocytes from deep layer

CS: Control chondrocytes from superficial layer

CD: Control chondrocytes from deep layer

^a: Pressure-loaded vs. control; p < 0.0001

^b: PS vs. CS; p < 0.0001

^c: PD vs. CD; p < 0.0001

^d: CS vs. CD; p = 0.0003

Table 3.2. Relative increase of chondrocyte apoptosis in the pressure-loaded experimental groups compared with the corresponding control groups (mean \pm SD)

Horse	PS/CS* (n=25)	PD/CD (n=25)
1	5.46 \pm 2.83	2.43 \pm 1.93
2	2.69 \pm 1.77	1.74 \pm 1.03
3	3.52 \pm 1.95	4.29 \pm 2.07
4	6.12 \pm 3.07	4.03 \pm 2.14

PS: Pressure-loaded chondrocytes from superficial layer

CS: Control chondrocytes from superficial layer

PD: Pressure-loaded chondrocytes from deep layer

CD: Control chondrocytes from deep layer

Mean \pm SD was calculated from all possible combinations of apoptosis percentages from 5 randomly selected microscopic areas of each experimental and control group.

*: PS/CS vs. CD/PD; $p < 0.0001$

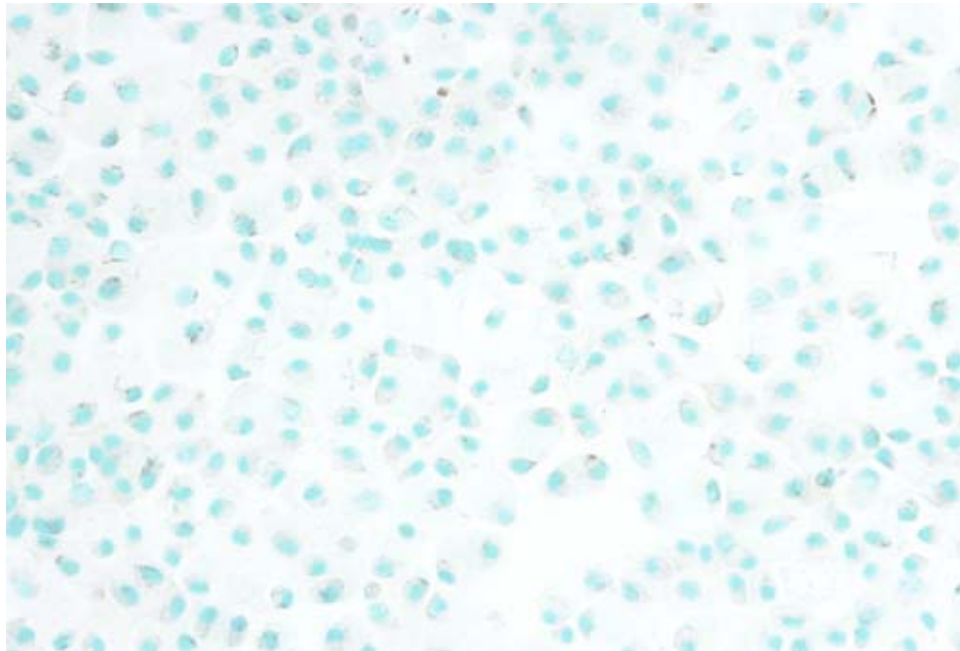

Figure 3.2. TUNEL staining for detection of apoptotic chondrocytes. The control chondrocytes that were isolated from superficial layers of equine articular cartilage and were not subjected to pressure. No chondrocytes are positively stained.

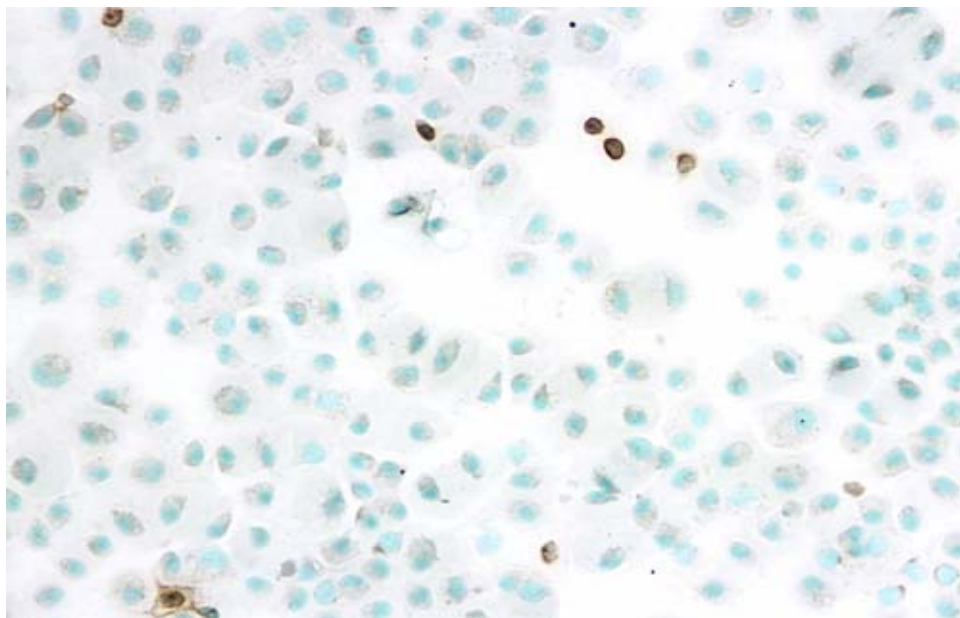

Figure 3.3. TUNEL staining for detection of apoptotic chondrocytes. The chondrocytes were isolated from superficial layers of equine articular cartilage and pressured with a cyclic hydrostatic pressure of 6.8 MPa for 12 hours. Note increased apoptotic chondrocytes over the control.

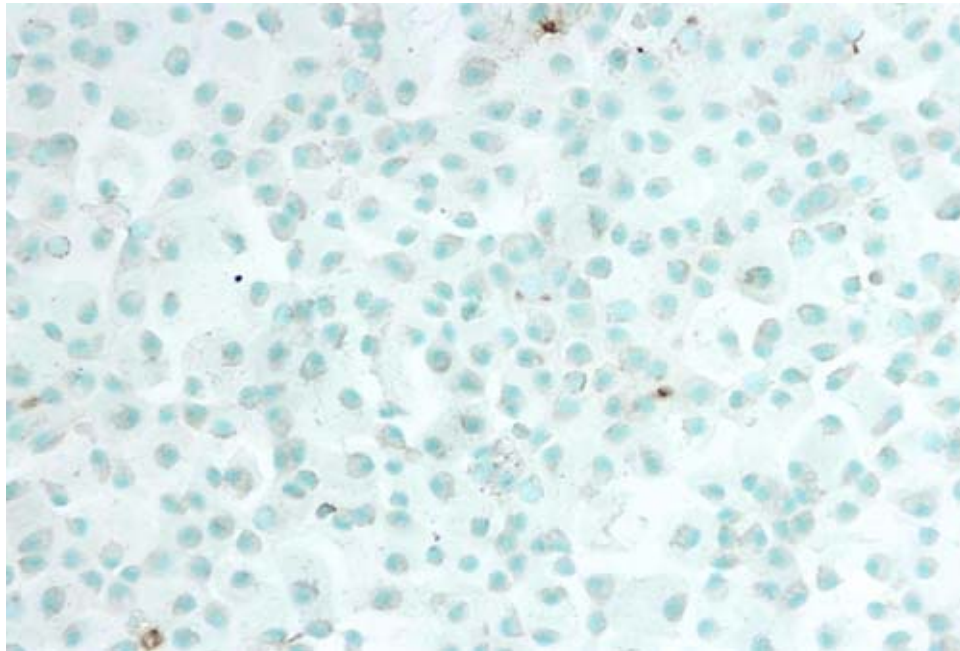

Figure 3.4. TUNEL staining for detection of apoptotic chondrocytes. The control chondrocytes that were isolated from deep layers of equine articular cartilage and were not subject to pressure. A few chondrocytes shows immunopositivity.

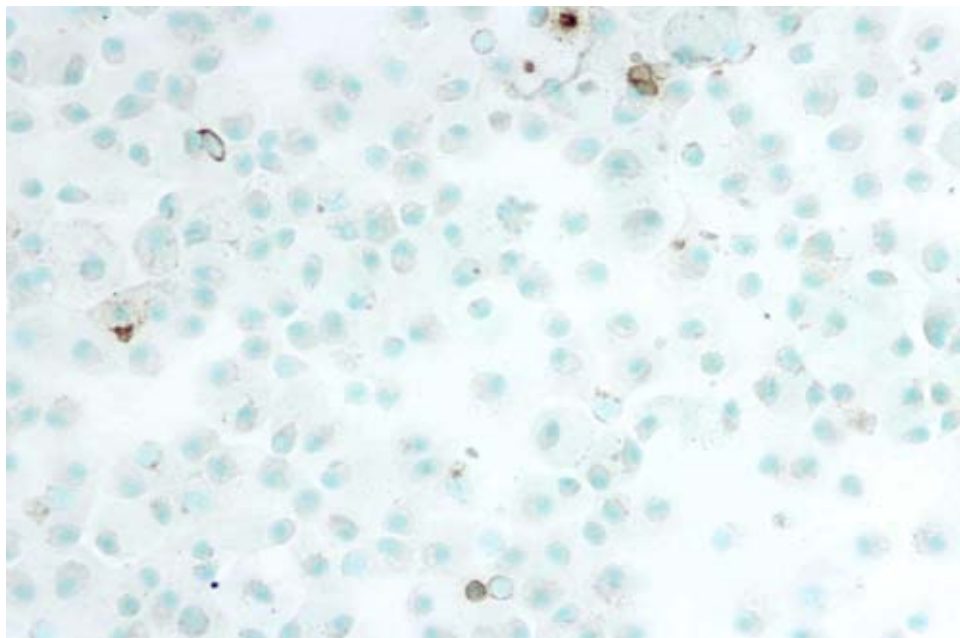

Figure 3.5. TUNEL staining for detection of apoptotic chondrocytes. The chondrocytes were isolated from deep layers of equine articular cartilage and pressured with a cyclic hydrostatic pressure of 6.8 MPa for 12 hours. Note increased apoptotic chondrocytes over the control.

Discussion

The cyclic hydrostatic pressure-loaded chondrocytes had a higher percentage of apoptosis than the control, suggesting that mechanical pressure could directly induce apoptosis of chondrocytes. Several *in vivo* (Hashimoto et al. 1998c; Hashimoto et al. 1999; Pelletier et al. 2000) and *in vitro* (Loening et al. 2000, Tew et al. 2000; Chen et al. 2001, Clements et al. 2001) experiments have demonstrated that increase in chondrocyte apoptosis can be induced by direct pressure impact on articular cartilage explants or by joint malalignment created by surgical anterior cruciate ligament transection. Loening and colleagues (2000) suggested that mechanical compression could directly induce chondrocyte apoptosis by demonstrating apoptotic chondrocytes without any sign of matrix degradation in the pressurized articular cartilage explants. There was still a possibility that the apoptosis was not a direct result from the pressure load but a secondary consequence from undetected, disrupted extracellular matrix due to the compression. Bendele and White (1987) observed the loss of fine granular material interspersed between collagen fibers in the superficial layer of articular cartilage as early as 24 hours after surgery in meniscectomized guinea pigs and disorganized collagen fibrils surrounding chondrocytes at 96 hours after surgery. Integrin-mediated attachment to extracellular matrix is crucial for chondrocyte survival (Loester 1993; Hirsch et al. 1997; Wright et al. 1997). Integrins are the chondrocytic transmembrane proteins that mediate chondrocyte adhesion to the extracellular matrix by interacting with fibronectins. Integrin $\alpha 5 \beta 1$ is most commonly expressed in human cartilage and believed to be a chondrocyte mechanoreceptor (Wright et al. 1997). Therefore, disruption of extracellular matrix by mechanical impact could cause chondrocyte apoptosis via dissociation of chondrocyte integrins from the extracellular matrix. Another possible factor for chondrocyte apoptosis in long-term experiments might be an elevated accumulation of fibronectin fragments. Accumulated fibronectin fragments are commonly found on the articular cartilages in human OA patients (Xie et al. 1992; Jones et al. 1987) and have been demonstrated in articular cartilage explants after cyclic mechanical impact (Farquhar et al. 1996). Fibronectin fragments induce matrix degradation by chondrolysis from up-regulated metalloproteinases (Homandberg et al. 1992) and by chondrocyte catabolism resulted from suppressed proteoglycan synthesis (Homandberg et al. 1993; Homandberg 1999). Xie and colleagues

(1993), however, suggested that fibronectin fragments did not directly cause chondrocyte death based on the measurements of tissue DNA content. This method is not considered to be appropriate to detect early apoptosis, however.

Apoptotic chondrocytes are often located in the superficial and upper middle layers of OA cartilage as well as in normal cartilage (Blanco et al. 1998; Hashimoto et al. 1998c). We demonstrated that a relative increase of apoptotic chondrocytes after the pressure loading was observed more in the superficial chondrocytes compared with the chondrocytes from deep layers. This finding is parallel to the results of the previous studies. Conversely, a higher percentage of apoptosis was noted in the control chondrocytes in deep layers than in those from superficial layers. Tew and colleague (2000) have shown that chondrocyte apoptosis increases at the edges of the mechanically wounded articular cartilages. Since the deep cartilage layer is much thicker than the superficial layer, it is possible that it received more physical damage than the superficial layer when cartilage specimens were minced with scalpel blades during sample preparation. This may explain why more frequent apoptosis occurred in the control deep layer chondrocytes than the control superficial layer chondrocytes.

This study demonstrated that a cyclic hydrostatic pressure of $1,000 \pm 100$ psi (approximately 6.8 ± 0.6 MPa) for 12 hours could induce chondrocyte apoptosis. Clements and colleagues (2000) observed that there was a threshold (6 MPa) of mechanical pressure to induce chondrocytic death; cell viability was inversely proportional to the applied pressure greater than 6 MPa. Loening and colleagues (2000) showed that repetitive compressive pressure as low as 4.5 MPa could cause chondrocyte apoptosis after six repetitive compression cycles in 3 hours.

Recently, contact pressure on the proximal articular cartilage of the equine proximal phalanx was measured with pressure sensitive sheets inserted between the articular surfaces (Brama et al. 2001). The contact pressure reaches 30-35 MPa, when a horse gallops and jumps, with maximum range of 40 to 45 MPa. These observed values appeared to be beyond the physiological pressure limit, which is approximately 20 MPa (Mow et al. 1999). The peak magnitude of the principal effective stress could be as low as 14 % of the peak contact stress at the articular surface (Ateshian et al. 1994). In a human patient, a pressure-measuring

Moore-type endoprosthesis that was implanted in a hip joint measured an 18 month post-surgical maximum pressure of 8.9 MPa when rising from a chair and 5.4 MPa when walking (Hodge et al. 1989). Therefore, our loading pressures of 6.8 Mpa are clinically relevant.

Articular cartilage is saturated with water. The water phase of cartilage constitutes 65% to 85% of the total tissue weight (Amstrong and Mow 1982; Setton et al. 1999). In the joints, high loads during weight bearing are predominantly transmitted via the hydrostatic pressure of the interstitial fluid of articular cartilage (Ateshian et al. 1994; Mow et al. 1999). In this study, we simulate this by pump-generated hydrostatic pressure. Culture medium flowed through the system continuously throughout the experimental period, even during the pressure-off cycles, at a flow rate of 1.5 ± 0.2 ml. Since the diameter of the glass columns was 10 mm, the flow rate within the HPLC columns was as low as approximately 0.32 ± 0.04 mm/sec. Therefore, the effect of shear stress within the experimental groups should not be significant.

Biochemical and structural properties of articular cartilage vary and depend on the topographical location, even in the same joint surface (Arokoski et al. 1999; Brama et al. 1999; Brama et al. 2000). Articular cartilage explants used in *in vitro* experiments may have a heterogeneity in anatomical and biochemical properties even if the specimens were consistently and carefully harvested from the same areas of the joint surfaces. In our *in vitro* system, since chondrocytes were separately collected from superficial and deep layers and homogenized during the preparation, the sample variation would be negligible.

If articular chondrocytes are cultured in monolayer environment, within hours, they morphologically transform to fibroblast-like cells producing type I collagen instead of type II, which is normally produced by mature chondrocytes (Green 1981; Benya and Shaffer 1982). To maintain normal chondrocyte characteristics, three-dimensional chondrocyte culture systems have been introduced with the scaffolds made of agarose gel, collagen, fibrin, alginate, or biodegradable synthetic polymers (reviewed by Perka et al. 2000). Alginate is a linear polysaccharide isolated from marine brown algae. The alginate solution instantly becomes a gel in presence of divalent cations like calcium and is easily solubilized by chelating agents, such as EDTA and citrate. Calcium alginate gels have been successfully

applied to maintain chondrocytes in tissue culture (Lemare et al. 1998; Lindenhayn K et al. 1999; Perka et al. 2000).

The present study using a novel hydrostatic pressure loading system demonstrated that chondrocyte apoptosis was directly induced by cyclic hydrostatic pressure, suggesting that chondrocyte apoptosis may be an early change of OA and may directly contribute to matrix degradation. This *in vitro* experimental system is useful to investigate physiological and pathological changes of pressure-related chondrocyte metabolism.

CHAPTER IV: INCREASED NITRIC OXIDE PRODUCTION AND BCL-2 AND CASPASE-3 EXPRESSION BY EQUINE ARTICULAR CHONDROCYTES UNDER CYCLIC HYDROSTATIC PRESSURE: LINKAGE TO CHONDROCYTE APOPTOSIS

Introduction

Pathologically, osteoarthritis (OA) is characterized by extracellular matrix degeneration and chondrocyte death. Recent studies indicate that chondrocyte death occurs predominantly by means of apoptosis (Blanco et al. 1998). The level of apoptosis is correlated with matrix breakdown (Blanco et al. 1998; Hashimoto et al. 1998a, 1998b, 1998c, 1999; Colwell et al. 2001), and chondrocyte apoptosis may result in matrix degeneration (Hashimoto et al 1998c; Loening et al 2000).

Apoptosis is a particular form of cell death with specific morphological features of condensed nuclei, membrane blebs, and apoptotic bodies separating from the apoptotic cells (Saikumar et al. 1999; Afford and Randhaw 2000; Geske et al. 2001). Chondrocyte apoptosis can be induced by various biochemical mediators including nitric oxide (NO) (Blanco et al. 1995; Kuhn and Lotz 2001; Teixeira et al. 2001), anti-Fas antibody (Hashimoto et al. 1997), prostaglandin E₂ (Miwa et al. 2000), tumor necrosis factor – alpha (Aizawa et al. 2001), ceramide (Sabatini et al. 2000), and hydrogen peroxide (Asada et al. 2001). Mechanical pressure load on articular cartilage is believed to be the major etiologic factor of OA and has been demonstrated to induce *ex vivo* chondrocyte apoptosis in articular cartilage explants (Loening et al 2000, Chen et al. 2001, Clements et al. 2001).

Apoptosis is frequently referred to as programmed cell death, which occurs by precisely regulated activation of a series of preexisting death programs, which are encoded in the genome. It is generally believed that control of apoptosis rests in the mitochondria (Finkel 2001). After exogenous death signals are received by various receptors on the cell membrane, there is subsequent activation of caspase-8 and pro-apoptotic Bcl-2 families, such as BAX and BAK, which cause release of cytochrome c from mitochondria into the cytoplasm. Released cytochrome c triggers activation of executor caspases-3, -6, and/or -7 causing cell death (reviewed by Huppertz et al. 1999; Saikumar et al. 1999; Geske et al. 2001; Finkel 2001).

NO is a free radical, acting as a pathophysiological mediator (Liaudet et al. 2000). NO is mainly produced by inducible nitric oxide synthase (iNOS) in articular chondrocytes.

Endogenous NO-induced chondrocyte apoptosis and the concentration of NO produced in the cartilage correlated with the destruction of extracellular matrix *in vivo* (Blanco et al. 1998; Hashimoto et al. 1998a, 1998c; Pelletier et al. 1998; Hashimoto et al. 1999). Although NO production, detected in the form of nitrites, increases in mechanically compressed articular cartilage explants (Loening et al. 2000), detailed mechanisms of how NO may initiate the apoptosis cascade are not fully understood. Chemical NO donors cause release of cytochrome c from mitochondria during HL-60 cell apoptosis (Yabuki et al. 2000) and activation of caspase-3 (Lee et al. 2000; Teixeira et al. 2001; Kim et al. 2002) and caspase-7 (Lee et al. 2000) in chondrocyte apoptosis. Recent studies indicate that extracellular signal-regulated protein kinase (ERK) –1/2 and p38 are linked to NO-induced apoptosis of chondrocytes (Notoya et al. 2000; Kim et al. 2002). Kim and colleagues (2002) suggest that p38 functions as an induction signal for apoptosis while ERK-1/2 operates as an anti-apoptotic signal.

Bcl-2 is one of a family of anti-apoptotic proteins that are located in the outer membrane of mitochondria and prevent mitochondrial permeabilization and release of cytochrome c (Yang et al. 1997). Bcl-2 expression is closely linked to chondrocyte apoptosis. Expression of Bcl-2 is elevated in OA articular cartilage (Kim et al. 2000; Pelletier et al. 2000). Withdrawing serum or treatment with retinoic acid increases expression of Bcl-2 in chondrocytes *in vitro* (Feng et al. 1998).

An immunohistochemical study revealed that expression of caspase-3 was significantly increased in OA articular cartilage and correlated with the severity of OA (Matsuo et al. 2001). Caspase-3 is up-regulated in chondrocyte apoptosis induced by exogenous NO (Notoya et al. 2000; Kim et al. 2002) and selective inhibitors of caspase-3 can inhibit chondrocyte apoptosis after treatment with NO donors (Lee et al. 2000).

This present study demonstrated that hydrostatic pressure-loaded chondrocytes isolated from equine articular cartilages have increased NO production and have increased Bcl-2 and caspase-3 expressions.

Materials and Methods

Equine Chondrocyte Isolation

Articular cartilage was obtained from surfaces of the distal metacarpal or metatarsal bones from 4 young horses (2 to 4 years old). The articular cartilage was grossly normal and

the horses had no history of joint-related disease. The horses had been submitted for either postmortem examination or other non-joint-related studies. The cartilage was collected within 3 hours of death. The joints were aseptically disarticulated and slivers of the superficial and deep layers of articular cartilages from the distal metacarpal or metatarsal bones were separately harvested with a scalpel blade and placed in chilled PBS (pH 7.4) in petri dishes. The collected cartilage slivers were finely minced into pieces 1mm or less in size and incubated in Ham's F12/DMEM medium (Life Technologies, Grand island, NY) containing filter-sterilized collagenase II (final concentration of 3mg/ml; Worthington Biochemical Corporation, Lakewood, NJ) overnight in an incubator (37C, 5% CO₂, in a humidified atmosphere). The remaining small fragments of cartilage were removed by gently and slowly passing the cell suspension through layers of autoclaved gauzes. The filtered cell suspension was centrifuged at 500x g for 10 minutes and the supernatant was discarded. The pelleted cells were washed twice more with sterile saline. A small amount (20 µl) of the cell suspension aliquot was collected and the cell numbers were determined by hemocytometer. Cell viability was determined after staining with trypan blue. The rinsed chondrocytes were suspended in saline containing 1.2% (v/v) alginate acid (sodium salt; Sigma, St. Louis, MO) in a volume of 1.5×10^6 cells/ml. The cell suspension was slowly expressed through a syringe and 22-gauge needle into a 102 mM CaCl₂ solution in 6-well cell culture plates and allowed to polymerize thereby forming uniformly-sized, 3 dimensional constructs, "beads", which contained the chondrocytes. After polymerization in the CaCl₂ solution for 10 minutes, the cell-laden beads were rinsed with sterile saline 3 times, Ham's F12/DMEM twice, and incubated in the complete Ham's F12/DMEM medium including antibiotics and 10% fetal bovine serum (Life Technology, Grand island, NY) until the pressure loading experiment (within 7 days). The medium was replaced every two days.

Application of Hydrostatic Pressure

The pressure loading system consisted of two HPLC glass columns, an isocratic HPLC pump, and a metering valve (Figure 3.1). Alginate beads embedded with either superficial or deep layer chondrocytes were separately installed in the HPLC glass columns (AP glass column; Waters, Milford, MA), which were connected to the isocratic HPLC pump, and were cyclically pressurized at $1,000 \pm 100$ psi (approximately 6.8 ± 0.6 MPa). The

pressure protocol consisted of repeated, 15 minute each on-off cycles for 12 hours. The peak pressure was reached within one minute in each cycle. The complete cell culture medium in the system was continuously recirculated throughout the experimental period. The chondrocyte-loaded HPLC columns and the complete culture medium were placed in a cell culture incubator at 37 °C in a humidified atmosphere with 5% CO₂. The pressure was carefully controlled and maintained with a metering valve (Hoke Fine Metering Valve; Alltech, Deerfield, IL) at a flow rate of 1.5 ± 0.2 ml/min. The culture medium continuously flowed at this rate in the system throughout the experimental period, even during pressure-off-cycles. For the controls, cell culture dishes containing superficial and deep layer chondrocytes in alginate beads were placed next to the glass columns in the incubator. After pressure treatment, the alginate beads were collected from the HPLC columns, placed in 2ml of complete medium, and incubated for 36 hours at 37 °C in a humidified atmosphere with 5% CO₂.

Nitrite Assay

A colorimetric assay, using Greiss reagents and sodium nitrite (NaNO₂) as the standard, was used to measure nitrite (NO₂) in the cell culture medium (2ml per each group) that was collected after the 36-hour-incubation following the pressure loading. In brief, 100 µl of each standard solution or sample medium was added to a 96-well cell culture plate on ice, mixed with 50 µl of freshly prepared sulfanilamide (10mg/ml in 5 % orthophosphoric acid; Sigma, St. Louis, MO), and incubated for 10 minutes under dimmed lights. The plate was removed from the ice and incubated for 30 minutes after adding 50 µl of NED [N-(1-naphthyl)ethylenediamine HCl; Sigma, St. Louis, MO] (1mg/ml in water) to each well. Absorbance at 550 nm wavelength was determined by a spectrophotometric plate reader. A nitrite standard graph and estimated concentrations of nitrite in the samples were statistically calculated by linear regression.

Immunocytochemistry for Bcl-2 and Caspase-3

The chondrocytes were isolated from the alginate beads by dissolution with EDTA (final concentration of 25 mM for 10 minutes) and washed twice with saline. The numbers of isolated chondrocytes in each group were counted with a hemocytometer. Approximately 5 x 10⁴ cells from each group were adhered to a glass slide by cytospin, fixed in chilled 1%

paraformaldehyde for 10 minutes, air-dried, and stored at -70°C for later use. For immunocytochemistry, the avidin-biotin-peroxidase complex method was used (Vectrastain[®] ABC kit, Vector Laboratories, Burlingame, CA). Chondrocytes on the slides were pretreated with 3% hydrogen peroxide for 5 minutes and 0.5% Triton X-100 solution for 5 minutes. Rabbit anti-human Bcl-2 polyclonal antisera and goat anti-human caspase-3 p20 subunit polyclonal antisera were used as primary antibodies (Santa Cruz Biotechnology). Diaminobenzidine tetrahydrochloride (DAB; Sigma, St. Louis, MO) was the chromogen for detection. For counter-staining, 0.5% Methyl green in 0.1M sodium acetate was applied for 10 min.

Data Analysis

The SAS statistical package (GLM procedure) was used to analyze the data. The data of nitrite concentrations from each group were normalized by log transformation. The log-transformed data were analyzed by analysis of variance in a Randomized Block Design with horse as the blocking factor and pressure-loading treatment, cartilage layer, and treatment and cartilage layer interactions as effects in the model. Pairwise comparisons were conducted with the LSMEANS option to obtain t-tests. All comparisons were considered significant at $p \leq 0.05$.

Results

Nitrite Assay

Nitrite in each 2 ml cell culture medium was calculated in micromolar concentration per 10^3 cells (Table 4.1). The pressure-loaded chondrocytes from the superficial layers of articular cartilages produced significantly higher concentrations of nitrite than the control group ($p=0.002$). The pressure-loaded deep layer chondrocytes also produced more nitrite than the control, although statistically not significant ($p=0.07$).

Immunocytochemistry for Bcl-2

Most superficial and deep layer chondrocytes from both control and pressure-loaded groups showed positive immunoreactivity for Bcl-2. But, pressure-loaded chondrocytes from both superficial and deep layers were more intensely stained with polyclonal Bcl-2 antibody (Figures 4.1 – 4.4). Positively stained pressure-loaded cells contained mostly fine, but only occasionally coarse, brown chromogen granules diffusely and uniformly scattered throughout

the cytoplasm. In contrast, control chondrocytes often had variably distributed, fine chromogen granules in the cytoplasm. In the control groups, deep layer chondrocytes exhibited stronger staining than chondrocytes from superficial layers.

Table 4.1. Nitrite concentration from pressure-loaded and control chondrocytes from equine articular cartilages ($\mu\text{M}/10^3$ cells)

Horse	PS ^a	CS	PD ^b	CD
1	11.99	2.02	18.03	5.52
2	26.53	15.80	22.96	20.28
3	28.23	10.43	28.70	20.50
4	64.67	26.14	88.80	66.51

PS: Pressure-loaded chondrocytes from superficial layer

CS: Control chondrocytes from superficial layer

PD: Pressure-loaded chondrocytes from deep layer

CD: Control chondrocytes from deep layer

^a : PS vs. CS, $p = 0.002$

^b : PD vs. CD, $p = 0.07$



Figure 4.1. Immunocytochemistry for Bcl-2 in the control chondrocytes isolated from superficial layers of equine articular cartilages. The cytoplasm is partially stained with fine chromogen particles.

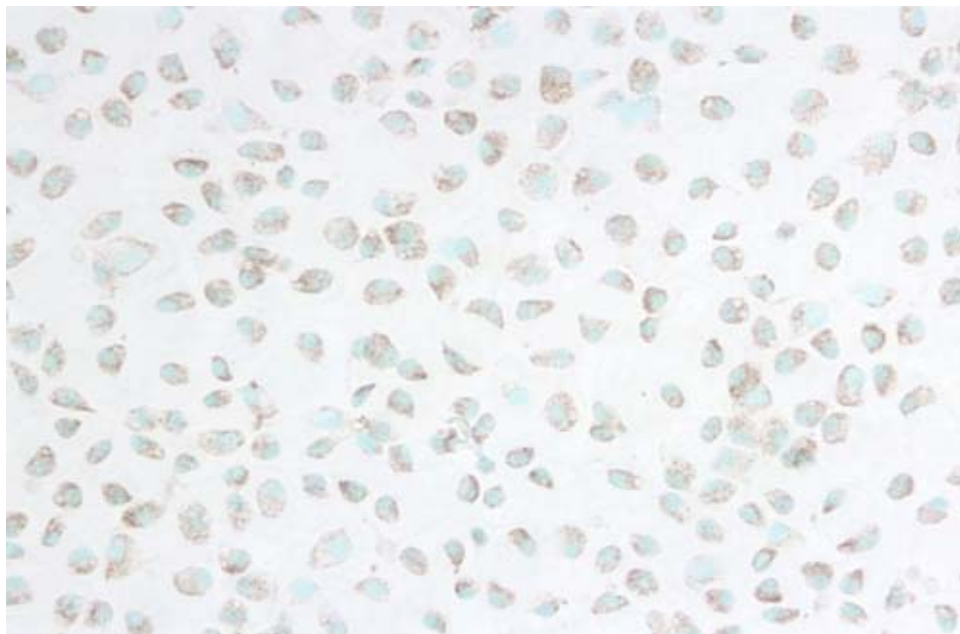

Figure 4.2. Immunocytochemistry for Bcl-2 in the hydrostatic pressure-loaded chondrocytes isolated from superficial layers of equine articular cartilages. Note the stronger immunopositivity compared with the control.

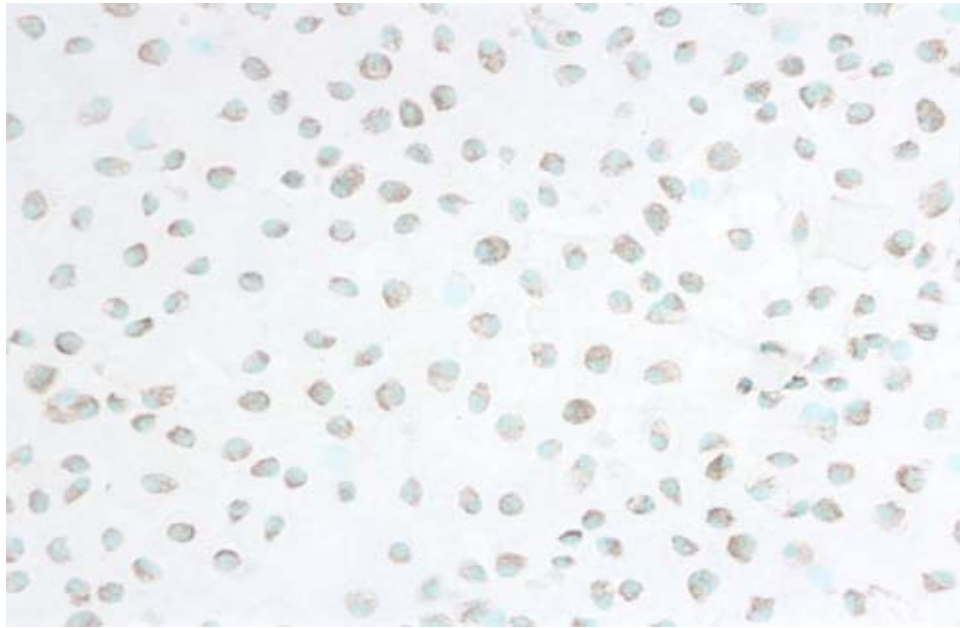

Figure 4.3. Immunocytochemistry for Bcl-2 in the control chondrocytes isolated from deep layers of equine articular cartilages. The cytoplasm is partially stained with fine chromogen granules while immunopositivity appears stronger than the control chondrocytes from superficial layers.

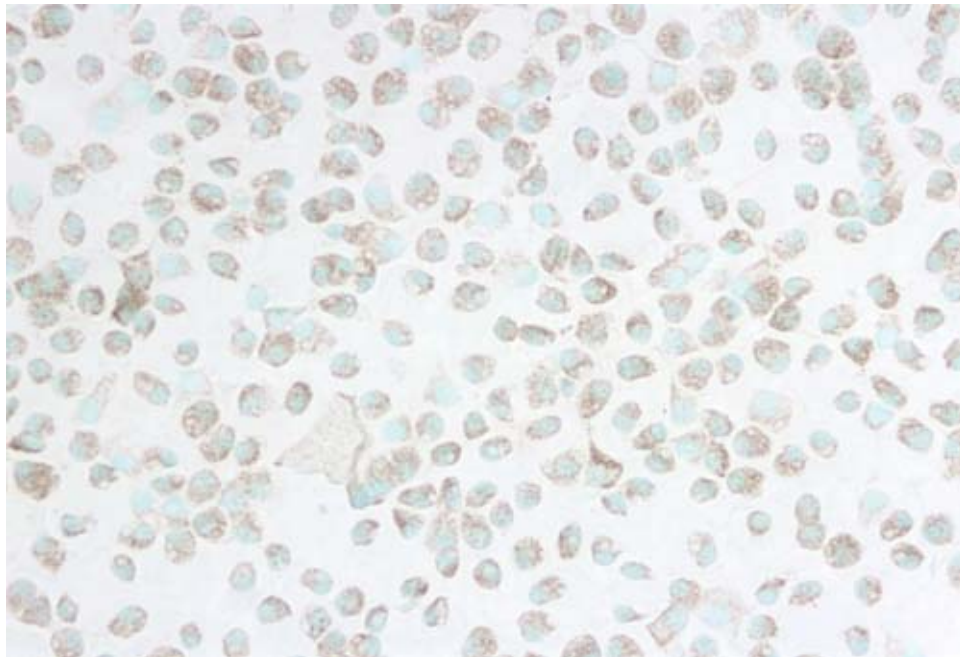

Figure 4.4. Immunocytochemistry for Bcl-2 in the hydrostatic pressure-loaded chondrocytes isolated from deep layers of equine articular cartilages. The cytoplasm is diffusely and strongly stained.

Immunocytochemistry for Caspase-3

The primary antibody used for this study was goat polyclonal antisera against human caspase-3 p20 subunits, which detect both pre-activated and activated forms of caspase-3. Pressure-loaded chondrocytes from both superficial and deep layers demonstrated higher immunoreactivity than the corresponding control groups (Figures 4.5 – 4.8). Two distinct patterns of immunocytochemical staining were noted between cytoplasm and nuclei. The cytoplasm contained partially to diffusely scattered fine chromogen granules, but the nuclei were discretely and densely stained. The pressure-loaded chondrocytes had more intense granular staining with chromogen granules in the cytoplasm and more frequently stained nuclei.

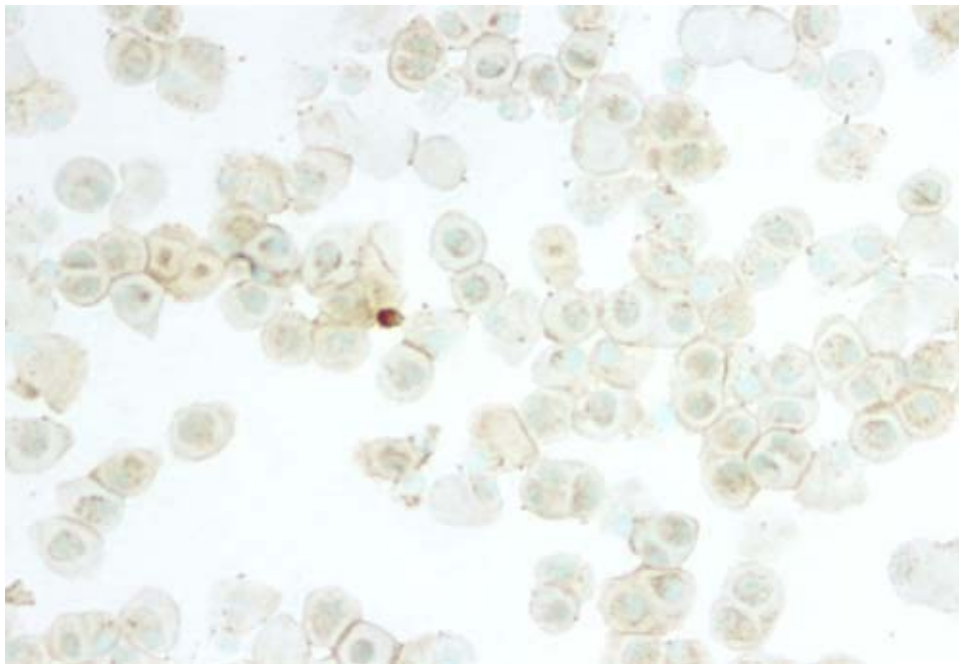

Figure 4.5. Immunocytochemistry for caspase-3 in the control chondrocytes isolated from superficial layers of equine articular cartilages. Note diffusely stained cytoplasm and occasional densely stained nuclei.

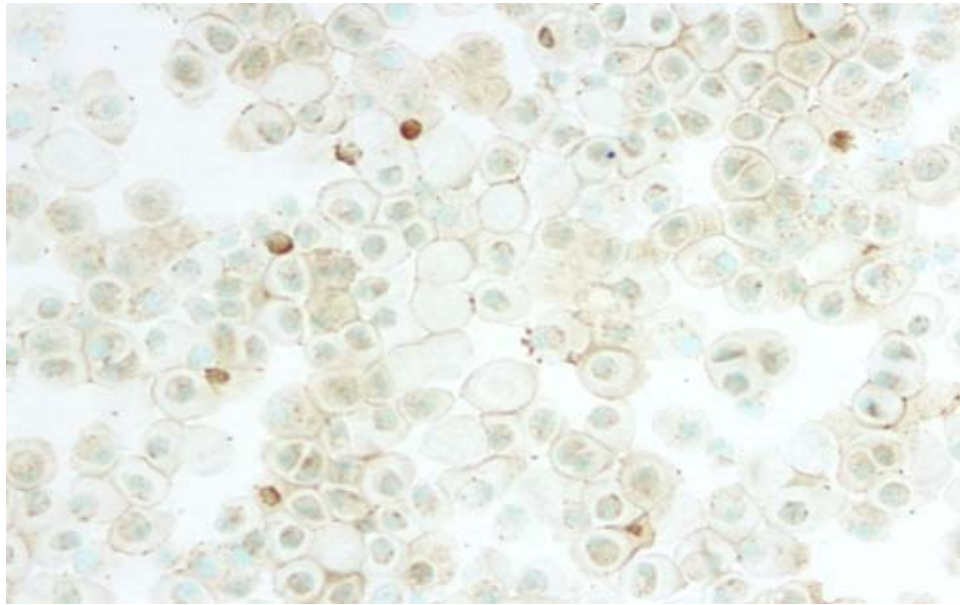

Figure 4.6. Immunocytochemistry for caspase-3 in the hydrostatic pressure-loaded chondrocytes isolated from superficial layers of equine articular cartilages. The densely stained nuclei are more frequent and the cytoplasm shows increased immunopositivity over the control.

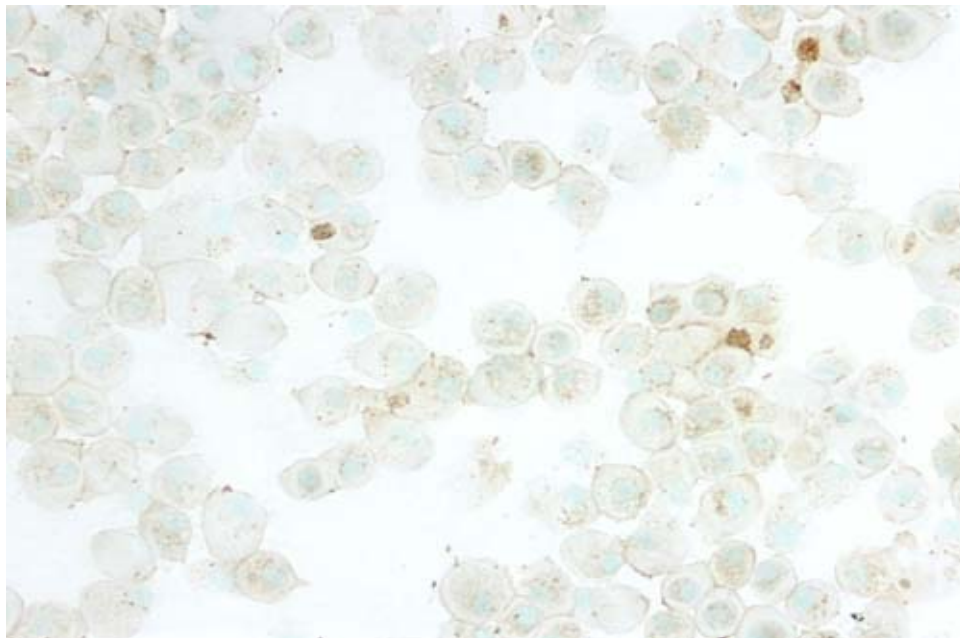

Figure 4.7. Immunocytochemistry for caspase-3 in the control chondrocytes isolated from deep layers of equine articular cartilages. Note diffusely stained cytoplasm and occasional densely stained nuclei.

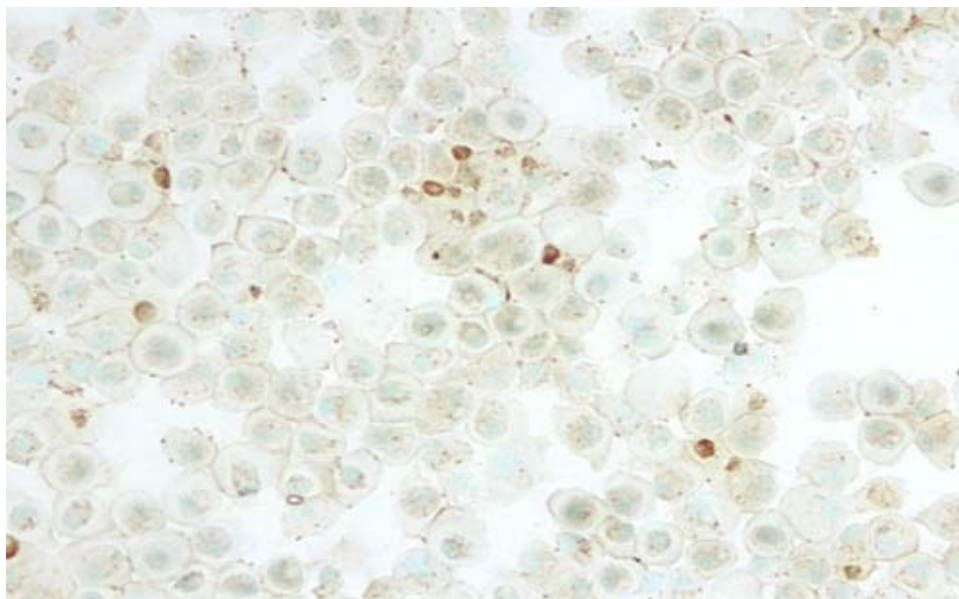

Figure 4.8. Immunocytochemistry for caspase-3 in the hydrostatic pressure-loaded chondrocytes isolated from deep layers of equine articular cartilages. Note frequently stained nuclei as well as much stronger immunopositivity in the cytoplasm compared with the control.

Discussion

The pressure-loaded equine articular chondrocytes produced increased NO production and had increased expression of Bcl-2 and caspase-3 compared with the control groups. These results were consistent with previous experimental results (chapter II) of chondrocyte apoptosis, which demonstrated that hydrostatic cyclic pressure induced increased chondrocyte apoptosis.

NO is a short-lived endogenous mediator with ambivalent actions; physiologic and pathologic (Liaudet et al. 2000). Excessive production of NO has been linked to cartilage catabolism (Hauselmann et al. 1998; Pelletier et al. 1998; Spreng et al. 2000) and chondrocyte apoptosis (Hashimoto et al. 1998c; Blanco et al. 1998; Hashimoto et al. 1999). The present study demonstrated that pressure-loaded equine articular chondrocytes produced higher concentrations of NO, in the form of nitrite, suggesting that mechanical pressure can be a direct cause of NO production in articular chondrocytes. The increased production of NO correlated with an increased percentage of apoptosis found in the pressure-loaded chondrocytes. Collectively, these observations suggest that increased NO may be responsible

for chondrocyte apoptosis induced by cyclic hydrostatic pressure. Recent studies have suggested that peroxynitrite, a potential pathologic byproduct of NO, may be the direct mediator for the NO-dependent apoptosis by ways of DNA injury, cell cycle arrest, mitochondrial damage, and activation of caspase-3 (Liaudet et al. 2000; Lee et al. 2000; Yabuki et al. 2000; Teixeira et al. 2001; Kim et al. 2002). NO and peroxynitrite can cause direct permeabilization of proteoliposomes containing adenine nucleotide translocator, one of the key components of the permeability transition pore complex in the mitochondrial membranes, resulting in release of cytochrome c into the cytoplasm and the consequential apoptosis (Vieira et al. 2001). Released cytochrome c activates caspase-9 by binding to the caspase-activating protein Apaf-1 (apoptotic protease activating factor-1). Subsequent activation of caspase-3, a potent execution caspase, occurs by activated caspase-9 (Saikumar et al. 1999). Conversely, NO also has been reported to have anti-apoptotic activity by delaying the apoptotic process (Leist et al. 1999).

Cell demise occurs mainly via two distinct pathways; apoptosis and necrosis. Chondrocyte necrosis has been identified in the mechanically damaged articular cartilages as well (Loening et al. 2000; Chen et al. 2001). Direct cellular trauma such as membrane rupture is a potential cause of the chondrocyte necrosis. A unique characteristic of apoptosis is the high-energy demand to execute the process (Eguchi et al. 1997). ATP depletion during apoptosis leads to failure of sequential activation of execution caspases, which are required for the characteristic morphology of apoptosis (Nicotera and Leist 1997). In those circumstances, the cells still die by switching the pathway of death from apoptosis to necrosis. NO has been implicated to inhibit mitochondrial ATP generation and switch apoptosis to necrosis (Leist et al. 1999). Therefore, when NO-dependent chondrocyte death occurs, not only apoptosis but also necrosis and secondary necrosis (overlapping processes) can be expected (Saikumar et al. 1999). Based on this idea, some of the cells that are stained positively with TUNEL method but have the morphology of necrosis (ruptured cell membrane) may not be falsely positive for apoptosis but may be secondary necrosis that began as apoptosis but completed as necrosis due to energy depletion by NO.

Bcl-2 is one of the anti-apoptotic proteins among the Bcl-2 family proteins. Anti-apoptotic members include Bcl-2, Bcl-X_L, Bcl-w, etc. and pro-apoptotic members are Bax,

Bak, Bid, Bim, Bad, etc. (Reed 2000). Bcl-2 has a hydrophobic domain of amino acids near its carboxy-terminus that anchors it in the outer mitochondrial membrane. Thus, it forms a heterodimer with another Bcl-2 family protein to assemble a permeability transition pore complex. In contrast, some other Bcl-2 family proteins like pro-apoptotic proteins Bid, Bim, and Bad lack the transmembrane domains to locate in the cytosol but still can translocate into mitochondria and form heterodimers with other Bcl-2 family proteins in the mitochondrial outer membrane. Pro-apoptotic Bcl-2 family proteins like Bax can release cytochrome c by forming pores in the mitochondrial membrane (Reed 2000; Geske et al. 2001). It is believed that the ratio of pro-apoptotic to anti-apoptotic Bcl-2 family proteins is important in determining cell fate (Adams and Cory 1998). In articular cartilages, Bcl-2 expression is increased in normal young human cartilages (Kim et al. 2000) and, interestingly, OA cartilages also show markedly elevated Bcl-2 expression (Kim et al. 2000; Pelletier et al. 2000). In conjunction with the results from our previous experiment, high pressure-loaded chondrocytes also showed increased cell apoptosis and concurrently elevated Bcl-2 expression. This finding of increased cell apoptosis with increased Bcl-2 expression might be a paradox because it is expected that high Bcl-2 would inhibit cell apoptosis. The pressure-loaded chondrocytes may attempt compensate for the adverse high-pressure condition with the up-regulation of Bcl-2 expression to escape apoptosis. Of the control groups, the chondrocytes from deep layers have higher expression of Bcl-2 than those from superficial layers. This result could be explained with the same reasoning, i.e. more mechanical damage during the sample preparation. In the previous experiment, chondrocytes from the deep layers exhibited increased apoptosis.

Caspase-3 is one of the most important execution caspases for completion of the apoptosis process after its activation by activated caspase-9 (Saikumar et al. 1999; Afford and Randhawa 2000; Reed 2000). Cytochrome c released from the mitochondria binds to Apaf-1 (apoptotic protease activating factor-1) and this complex activates procaspase-9. Increased expression of caspase-3 was confirmed in human OA articular cartilages and surgically induced canine OA models. This expression was correlated with chondrocyte apoptosis and OA lesions (Pelletier et al. 2000; Matsuo et al. 2001). NO-induced apoptotic chondrocytes up-regulate caspase-3 (Notoya et al. 2000; Kim et al. 2002). In a dose-dependant manner,

selective inhibitors of caspase-3 decrease caspase-3 expression as well as decreasing chondrocyte apoptosis (Lee et al. 2000; Pelletier et al. 2000). This present *in vitro* study reconfirms that increased amounts of endogenous NO, induced by high-pressure load, are correlated with high caspase-3 expression in the articular chondrocytes.

In summary, we have shown that cyclic hydrostatic pressure can induce equine articular chondrocyte apoptosis with increased NO production and increased Bcl-2 and caspase-3 expressions. This *in vitro* experiment demonstrated that mechanical stress could be a major cause of chondrocyte apoptosis. Pressure-induced NO production may play a critical role in the chondrocyte apoptotic process through Bcl-2 and caspase-3 mediated mechanisms.

SUMMARY

We studied the roles of chondrocyte apoptosis and hydrostatic pressure in the pathogenesis of equine osteoarthritis. Chondrocyte apoptosis occurred much more frequently in equine OA cartilages than normal cartilages of horses. Within the same OA cartilage, more apoptotic chondrocytes were found in the lesional area than in the non-lesional area. Chondrocyte apoptosis and degradation of equine articular cartilage were closely correlated. A high incidence of chondrocyte apoptosis was noted in the severely degraded cartilage matrix. These findings seemed to corroborate earlier observations in human and experimental OA (Blanco et al. 1998; Hashimoto et al. 1998a; Hashimoto et al. 1998c; Pelletier et al. 1998; Kim et al. 2000). In addition, the observation of frequent chondrocyte apoptosis at the margins of the may indicate that chondrocyte apoptosis precedes and may cause matrix degeneration. This is further supported by increased apoptosis in the non-leisonal areas compared with normal cartilage. Immunohistochemical studies revealed concurrently increased endogenous NO production by chondrocytes and matrix degradation. The topographic distribution of chondrocyte apoptosis, matrix degradation, and endogenous NO completely overlapped in equine OA cartilage, suggesting each pathological change is closely related to the others in the pathogenesis of equine OA.

Mechanical stress is believed to be a major factor of OA and hydrostatic pressure is a major physical force that is generated in articular joints (Ateshian et al. 1994; Mow et al. 1999). Cyclic hydrostatic pressure (approximately 6.8 ± 0.6 MPa) for 12 hours in a novel pressure-loading system induced a high percentage of apoptosis of equine chondrocytes compared with non-loaded, control chondrocytes. This observation suggests that mechanical stress may directly induce chondrocyte apoptosis. The finding of mechanically-induced chondrocyte apoptosis without any apoptosis-related factor from the extracellular matrix supports the hypothesis that chondrocyte apoptosis may be an early change of OA and may precede matrix degradation. We demonstrated that a relative increase of apoptotic chondrocytes after the pressure loading was observed more in the superficial chondrocytes, compared with the chondrocytes from deep layers. This result agrees with the findings in other *in vivo* studies (Blanco et al. 1998; Hashimoto et al. 1998c).

The pressure-loaded equine articular chondrocytes produced increased NO compared with the control group. This observation is consistent with the frequent incidence of chondrocyte apoptosis in the *in vitro* pressure-loading experiments as well as in the *in vivo* equine OA cartilages. The pressure-loaded chondrocytes showed elevated Bcl-2 and caspase-3 expressions. Increased cell apoptosis in the presence of increased Bcl-2 expression is paradoxical because Bcl-2 is an inhibitor of cell apoptosis. It is conceivable that the chondrocytes may try to compensate for the adverse high-pressure condition by the up-regulation of Bcl-2 expression in an attempt to escape apoptosis. Increased caspase-3 expression in the pressure-loaded chondrocytes in this study confirmed that endogenous NO production and caspase-3 expression are concurrently increased in the articular chondrocytes.

Collectively, we have shown that hydrostatic pressure induces chondrocyte apoptosis that is associated with increased production of endogenous NO and elevates expressions of Bcl-2 and caspase-3. This *in vitro* experiment demonstrates that mechanical stress could be a major cause of chondrocyte apoptosis without prior extracellular matrix changes because matrix was absent from this system. Pressure-induced NO has a critical role in the chondrocyte apoptosis process through caspase-3 mediated mechanisms in spite of Bcl-2 up-regulation. Because mechanical stress, i.e. trauma, is believed to be the major cause of equine OA, the data generated herein supports endogenous NO-induced chondrocyte apoptosis as a potential mechanism for the pathogenesis of OA. Furthermore, Bcl-2 and caspase-3 are supported as regulatory or mediating factors in this process.

Our pressure-loading system successfully provided an experimental high-pressure condition, which is similar to that in the articular joints. It is an advantageous *in vitro* system, which is easy to control and manipulate experimentally. Our system may be used to examine specific biological actions and interactions of chondrocytes under high pressure and may be useful to elaborate and elucidate mechanisms of chondrocyte apoptosis.

BIBLIOGRAPHY

- Adams JM, Cory S. 1998. The Bcl-2 family: arbiters of cell survival. *Science* 281:1322-1326.
- Afford S, Randhawa S. 2000. Apoptosis. *J Clin Pathol* 53: 55-63.
- Aigner T, Bertling W, Stoss H, Weseloh G, von der Mark K. 1993. Independent expression of fibril-forming collagen I, II, and III in chondrocytes of human osteoarthritis cartilage. *J Clin Invest* 91: 829-837.
- Ambrosini G, Adida C, Altieri DC. 1997. A novel anti-apoptotic gene, survivin, expressed in cancer and lymphoma. *Nat Med* 3:917-921.
- Amstrong CG, Mow VC. 1982. Variations in the intrinsic mechanical properties of human cartilage with age, degeneration, and water content. *J bone Jt Surg* 64A:88-94.
- Anderson J and Felson D. 1988. Factors associated with osteoarthritis of the knee in the first national health and nutritional examination survey (HANES I). *Am J Epidemiol* 128: 179-189.
- Archer CW, Morrison H, Pitsillides AA. 1994. Cellular aspects of the development of diarthrodial joints and articular cartilage. *J Anat* 184: 447-456.
- Arokoski JPA, Hyttinen MM, Helminen HJ, Jurvelin JS. 1998. Biochemical and structural characteristics of canine femoral and tibial cartilage. *J Biomed Mater Res (Appl Biomater)* 48: 99-107.
- Asada S, Fukuda K, Nishisaka F, Matsukawa M, Hamanisi C. 2001. Hydrogen peroxide induces apoptosis of chondrocytes: involvement of calcium ion and extracellular signal-regulated protein kinase. *Inflamm Res* 50:19-23.
- Ateshian GA, Lai WM, Zhu WB, Mow VC. 1994. An asymptotic solution for the contact of two biphasic cartilage layers. *J Biomechanics* 27:1347-1360.
- Aizawa T, Kon T, Einhorn TA, Gerstenfeld LC. 2001. Induction of apoptosis in chondrocytes by tumor necrosis factor-alpha. *J Orthop Res* 19:785-796.
- Barrett AJ and Saklatvala J. 1985. Proteinases in joint disease. In: *Textbook of rheumatology*. Eds. WN Kelley, ED Harris, S Ruddy, CB Sledge. WB Saunders, Philadelphia, pp 182-196.
- Bayliss MT. 1992. Metabolism of animal and human osteoarthritic cartilage. In *Articular cartilage an osteoarthritis*. Eds. KE Kuettner, R Schleyerbach, JG Peyron, VC Hascall. Raven Press, New York, pp 487-500.

- Beckman JS. 1994. Peroxynitrite versus hydroxyl radical. *Ann NY Acad Sci* 738: 69-75.
- Beierley VH, Ayad S, Grant ME. 1991. Types II, VI and IX collagens in normal and osteoarthritic human articular cartilage. *Biochem Soc Trans* 19: 379S.
- Bendele AM, White SL. 1987. Early histopathologic and ultrastructural alterations in femorotibial joints of partial medial meniscectomized guinea pigs. *Vet Pathol* 24:436-443.
- Benya DP, Shaffer DJ. 1982. Dedifferentiated chondrocytes reexpress the differentiated collagen phenotype when cultured in agarose gels. *Cell* 30:215-224.
- Blanco FJ, Ochs RL, Schwarz H, Lotz M. 1995. Chondrocyte apoptosis induced by nitric oxide. *Am J Pathol* 146:75-85.
- Blanco FJ, Guitian R, Vazquez-Martul E, de Toro F, Galdo F. 1998. Osteoarthritis chondrocytes die by apoptosis. *Arthritis Rheum* 41: 284-289.
- Brama PAJ, TeKoppele JM, Bank RA, van Weeren PR, Barneveld A. 1999. Influence of site and age on biochemical characteristics of the collagen network of equine articular cartilage. *Am J Vet Res* 60: 341-345.
- Brama PAJ, TeKoppele JM, Bank RA, Karssenberg D, Barneveld A, van Weeren PR. 2000. Topographical mapping of biochemical properties of articular cartilage in the equine fetlock joint. *Equine Vet J* 32: 19-26.
- Buckwalter JA, Mankin HJ. 1998. Articular cartilage: Degeneration and osteoarthritis, repair, regeneration, and transplantation. *AAOS Instructional Course Lectures* 47: 487-504.
- Buckwalter JA, Mow VC, Ratcliffe A. 1994. Restoration of injured or degenerated articular cartilage. *J Am Acad Orth Sur* 2: 192-201.
- Bulstra SK, Buraman WA, Walenkamp HIM, vander Linden AJ. 1989. Metabolic characteristics of in vitro cultured human chondrocytes in relation to the histopathologic grade of osteoarthritis. *Clin Orthop* 242:294-302.
- Burton-Wurster N, Vernier-Singer M, Farquhar T, Lust G. 1993. Effects of compressive loading and unloading on the synthesis of total protein, proteoglycan, and fibronectin by canine cartilage explants. *J Orthop Res* 11: 717-726.
- Cantley CEL, Firth EC, Delahunt JW, Pfeiffer DW, Thompson KG. 1999. Naturally occurring osteoarthritis in the metacarpophalangeal joints of wild horses. *Equine Vet J* 31: 73-80.
- Clark JM. 1991. Variation of collagen fiber alignment in a joint surface: a scanning electron microscope study of the tibial plateau in dog, rabbit, and man. *J Orthop Res* 9: 246-257.

Clarke PG, Posada A, Primi MP, Castagne V. 1998. Neuronal death in the central nervous system during development. *Biomed Pharmacother* 52:356-362.

Clegg PD, Burke RM, Coughlan AR, Riggs CM, Carter SD. 1997. Characterisation of equine matrix metalloproteinase 2 and 9; and identification of the cellular sources of these enzymes in joints. *Equine Vet J* 29:335-342.

Clements KM, Bee ZC, Crossingham GV, Adams MA, Sharif M. 2001. How severe must repetitive loading be to kill chondrocytes in articular cartilage? *Osteoarthritis Cartilage* 9: 499-507.

Cohen GM. 1997. Caspases: the executioners of apoptosis. *Biochem J* 326:1-16.

Colwell CW Jr, D'Lima DD, Hoenecke HR, Fronck J, Pulido P, Morris BA, Chung C, Resnick D, Lotz M. 2001. In vivo changes after mechanical injury. *Clin Orthop* 391 Suppl:S116-123.

Copper C. 1994. Osteoarthritis Epidemiology. In: *Rheumatology*. Eds. Klippel J, Dieppe P. Mosby, London, pp 7.3.1-7.3.4.

Das P, Schurman DJ, Smith RL. 1997. Nitric oxide and G proteins mediate the response of bovine articular chondrocytes to fluid-induced shear. *J Orthop Res* 15:87-93.

Eguchi Y, Shimizu S, Tsujimoto Y. 1997. Intracellular ATP levels determine cell death fate by apoptosis or necrosis. *Cancer Res* 57:1835-1840.

Ellis HM, Horvitz HR. 1986. Genetic control of programmed cell death in the nematode *C. elegans*. *Cell* 44:817-829.

Enari M, Sakahira H, Yokoyama H, Okawa K, Iwamatsu A, Nagata S. 1998. A caspases-activated DNase that degrades DNA during apoptosis, and its inhibitor ICAD. *Nature* 391:43-50.

Eyre DR, Wu J-J, Woods PE. 1992. Cartilage-specific collagens: structural studies. In: *Articular cartilage and osteoarthritis*. Eds. KE Kuettner, R Schleyerbach, JG Peyron, VC Hascall. Raven Press, New York, pp. 119-131.

Evans CH, Brown TD. 1993. Role of physical and mechanical agents in degrading the matrix. In: *Joint cartilage degeneration*. Eds. JF Woessner, D Howell. Marcel Dekker, New York, pp 187-208.

Farquhar T, Xia Y, Mann K, Bertram J, Burton-Wurster N, Jelinski L, Lust G. 1996. Swelling and fibronectin accumulation in articular cartilage explants after cyclical impact. *J Orthop Res* 14:417-423.

- Felson D. 1988. Epidemiology of hip and knee osteoarthritis. *Epidemiol Rev.* 10: 1-28.
- Felson D. 1993. The course of osteoarthritis and factors that affect it. *Rheum Dis Clin North Am* 19: 607-615.
- Felson DT, Hannan MT, Naimark A, Berkeley J, Gordon G, Wilson PW, Anderson J. 1991. Occupational physical demands, knee bending, and knee osteoarthritis: results from the Framingham Study. *J Rheumatol* 18: 1578-1592.
- Feng L, Precht P, Balakit R, Horton WE Jr. Evidence of a direct role for Bcl-2 in the regulation of articular chondrocyte apoptosis under the conditions of serum withdrawal and retinoic acid treatment. *J Cell Biochem* 71:302-309.
- Finkel E. 2001. The mitochondrion: Is it central to apoptosis. *Science* 292:624-626.
- Freemont AJ, Hampson V, Tilman R, Goupille P, Taiwo Y, Hoyland JA. 1997. Gene expression of matrix metalloproteinases 1, 3, and 9 by chondrocytes in osteoarthritic human knee articular cartilage is zone and grade specific. *Ann Rheum Dis* 56:542-549.
- French LE, Tschopp J. 1996. Constitutive Fas ligand expression in several non-lymphoid mouse tissues: implications for immune-protection and cell turnover. *Behring Inst Mitt* 97:156-160.
- Gardner. 1994. Problems and paradigms in joint pathology. *J Anat* 184: 465-476.
- Geng YJ. 1997. Regulation of programmed cell death or apoptosis in atherosclerosis. *Heart Vessels* 12(Suppl.):76-80.
- Giancotti FG, Ruoslahti E. 1999. Integrin signaling. *Science* 285: 1028-1032.
- Goillot E, Raingeaud J, Ranger A, Tepper RI, Davis RJ, Harlow E, Sanchez I. 1997. Mitogen-activated protein kinase-mediated Fas apoptotic signaling pathway. *Proc Natl Acad Sci USA* 94: 3302-3307.
- Grant WT, Sussman MD, Balian G. 1985. A disulfide-bonded short chain collagen synthesized by degenerative and calcifying zones of bovine growth plate. *J Biol Chem* 260:3798-3803.
- Green WT Jr. 1981. Behavior of articular chondrocytes in cell culture. *Clin orthop* 75:248-260.
- Grossmann J, Mohr S, Lapentina EG, Fiocchi C, Levine AD. 1998. Sequential and rapid activation of select caspases during apoptosis of normal intestinal epithelial cells. *Am J Physiol* 274:G1117-G1124.

- Hauselmann HJ, Stefanovic-Racic M, Michel BA, Evans CH. 1998, Difference in nitric oxide production by superficial and deep human articular chondrocytes: implications for proteoglycan turnover in inflammatory joint diseases. *J Immunol* 160:1444-1448.
- Hashimoto S, Setareh M, Ochs RL, Lotz M. 1997. Fas/Fas ligand expression and induction of apoptosis in chondrocytes. *Arthritis Rheum* 40:1749-1755.
- Hashimoto S, Ochs RL, Komiya S, Lots M. 1998a. Linkage of chondrocyte apoptosis and cartilage degradation in human Osteoarthritis. *Arthritis Rheum* 41: 1632-1638.
- Hashimoto S, Ochs RL, Rosen F, Quach J, McCabe G, Solan J, Seegmiller JE, Terkeltaub R, Lotz M. 1998b. Chondrocyte-derived apoptotic bodies and calcification of articular cartilage. *Proc Natl Acad Sci USA* 95: 3094-3099.
- Hashimoto S, Takahashi K, Amiel D, Coutts R, Lotz M. 1998c. Chondrocyte apoptosis and nitric oxide production during experimentally induced osteoarthritis. *Arthritis Rheum* 41: 1266-1274.
- Hashimoto S, Takahashi K, Ochs RL, Coutts RD, Amiel D, Lotz M. 1999. Nitric oxide production and apoptosis in cells of the meniscus during experimental osteoarthritis. *Arthritis Rheum* 42:2123-2131.
- Heinegard D, Oldberg A. 1989. Structure and biology of cartilage and bone matrix non-collagenous macromolecules. *FASEB Journal*. 3: 2042-2051.
- Hering TM. 1999. Regulation of chondrocyte gene expression. *Front Biosci* 4: 743-761.
- Hirsch MS, Lunsford LE, Trinkaus-Randall V, Svoboda K.K.H. 1997. Chondrocyte survival and differentiation in situ are integrin mediated. *Dev Dyn* 210:249-263.
- Hodge WA, Carlson KL, Fijan RS, Burgess RG, Riley PO, Harris WH, Mann RW. 1989. Contact pressures from an instrumental hip endoprosthesis. *J Bone and Joint Surg* 71A:1378-1386.
- Hoffatt OD, Devitt A, Bell ED, et al. 1999. Macrophage recognition of ICAM-3 on apoptotic leukocytes. *J Immunol* 162:6800-6810.
- Hoffman KD, Pool RR, Pascoe JR. 1984. Degenerative joint disease of the proximal interphalangeal joints of the forelimbs of two young horses. *Equine Vet J* 16:138-140.
- Hoffman K, Tschopp J. 1995. The death domain motif found in Fas (Apo-1) and TNF receptor is present in proteins involved in apoptosis and axonal guidance. *FEBS Lett* 371:321-323.

- Homandberg GA, Meyers R, Xie D. 1992. Fibronectin fragments cause chondrolysis of bovine articular cartilage slices in culture. *J Biol Chem* 267:3797-3604
- Homandberg GA, Meyers R, Williams JM. 1993. Intraarticular injection of fibronectin fragments causes severe depletion of cartilage proteoglycans in vivo. *J Rheumatol* 20:1378-1382.
- Homandberg GA. 1999. Potential regulation of cartilage metabolism in osteoarthritis by fibronectin fragments. *Front Biosci* 4:713-730.
- Howell D, Muller F, Manicourt D. 1992. A mini review: Proteoglycan aggregate profiles in the Pond-Nuki dog model of osteoarthritis and in canine disuse atrophy. *Br J Rheumatol* 31:7-11.
- Hoyland GA, Thomas JT, Donn R, Marriott A, Ayad S et al. 1991. Distribution of type X collagen mRNA in normal and osteoarthritic human cartilage. *Bone Miner Res* 15:151-154.
- Huppertz B, Frank H-G, Kaufmann P. 1999. The apoptosis cascade – morphological and immunohistochemical methods for its visualization. *Anat Embryol* 200:1-18.
- Hutton WC, Elmer WA, Boden SD, Hyon S, Toribatake Y, Tomita K, Hair GA. 1999. The effect of hydrostatic pressure on intervertebral disc metabolism. *Spine* 24:1507-1515.
- Inerot S, Heinegard D, Olsson S-E, Telhag H, Audell L. 1991. Proteoglycan alterations during developing experimental osteoarthritis in a novel hip joint model. *J Orthop Res* 9:658-673.
- Johnson B. 1993. A look at racetrack breakdowns-1991. *J Equine Vet Sci* 13:129-132.
- Jones KL, Brown M, Ali SY, Brown RA. 1987. An immunohistochemical study of fibronectin in human osteoarthritis and disease-free articular cartilage. *Ann Rheum Dis* 46:809-815.
- Kalams SA, Walker BD. 1998. The critical need for CD4 help in maintaining effective cytotoxic T lymphocyte responses. *J Exp Med* 188:2199-2204.
- Kashiwagi A, Hanada H, Yabuki M, Kanno T, Ishisaka R, Sasaki J, Inoue M, Utsumi K. 1999. Tyroxine enhancement and the role of reactive oxygen species in tadpole tail apoptosis. *Fee Rad Biol Med* 26:1001-1009.
- Kelekar A, Thompson CB. 1998. Bcl-2 family proteins: the role of the BH3 domain in apoptosis. *Trends Cell Biol* 8:324-330.
- Kidd JA, Fuller C, Barr ARS. 2001. Osteoarthritis in the horse. *Equine Vet Educ* 13:160-168.

Kim HA, Lee YJ, Seong S-C, Choe KW, Song YW. 2000. Apoptotic chondrocyte death in human osteoarthritis. *J Rheumatol* 27:455-462.

Kim SJ, Ju JW, Oh CD, Yoon YM, Song WK, Kim JH, Yoo YJ, Bang OS, Kang SS, Chun JS. 2002. ERK-1/2 and p38 kinase oppositely regulate nitric oxide-induced apoptosis of chondrocytes in association with p53, caspase-3, and differentiation status. *J Biol Chem* 277:1332-1339.

Kiviranta I, Jurvelin J, Tammi M, Saamanen A-M, Helminen HJ. 1987. Weight bearing controls glycosaminoglycan concentration and articular cartilage thickness in the knee joints of young beagle dogs. *Arth Rheum* 30:801-809.

Kraus VB. 1997. Pathogenesis and treatment of osteoarthritis. *Adv Rheumatol* 81: 85-112.

Kuhn K, Lotz M. 2001. Regulation of CD95 (Fas/APO-1)-induced apoptosis in human chondrocytes. *Arth Rheum* 44:1644-1653.

Lavernia CJ, Sierra RJ, Gomez-Marin O. 1999. Smoking and joint replacement: resource consumption and short-term outcome. *Clin Orthop*. 367: 172-180.

Lee D, Long SA, Adams JL, Chan G, Vaidya, KS, Francis TA, Kikly K, Wnkler JD, Sung C-M, Debouck C, Richardson S, Levy MA, DeWolf Jr WE, Keller PM, Tomaszek T, Head MS, Ryan MD, Haltiwanger RC, Liang P-H, Janson CA, McDevitt PJ, Johanson K, Concha NO, Chan W, Abdel-Meguid SS, Badger AM, Lark MW, Nadeau DP, Suva LJ, Gowen M, Nuttall ME. 2000. Potent and selective nonpeptide inhibitors of caspase 3 and 7 inhibit apoptosis and maintain cell functionality. *J Biol Chem* 275:16007-16014.

Lee DA, Frean SP, Lees P, Bader DL. 1998a. Dynamic mechanical compression influences nitric oxide production by articular chondrocytes seeded in agarose. *Biochem Biophys Res Comm* 251:580-585.

Lee DA, Noguchi T, Knight MM, O'Donnell L, Bentley G, Bader DL. 1998b. Response of chondrocyte subpopulations cultured within unloaded and loaded agarose. *J Orthop Res* 16: 726-733.

Leist M, Single B, Naumann H, Fava E, Simon B, Kuhnle S, Nicotera P. 1999. *Exp Cell Res* 249:394-403.

Lemare F, Steimberg N, Le Griel C, Demignot S, Adolphe M. 1998. Dedifferentiated chondrocyte cultured in alginate beads: Restoration of the differentiated phenotype and of the metabolic responses to interleukin-1 β . *J Cell Physiol* 176:303-313.

Li H, Zhu H, Xu CJ, Yuan J. 1998. Cleavage of BID by caspases 8 mediates the mitochondrial damage in the Fas pathway of apoptosis. *Cell* 94:491-501.

Liaudet L, Soriano FG, Szabo C. 2000. Biology of nitric oxide signaling. *Crit Care Med* 28 (Suppl):N37-N52.

Lincz LF. 1998. Deciphering the apoptotic pathway: all roads lead to death. *Immunol Cell Biol* 76:1-19.

Lindenhayn K, Perka C, Spitzer R-S, Heilmann H-H, Pommerening K, Mennicke J, Sittinger M. 1998. Retention of hyaluronic acid in liginate beads: Aspects for in vitro cartilage engineering. *J Biomed Mater Res* 44:149-155.

Loening AM, James IE, Levenston ME, Bader AM, Frank EH, Kurz B, Nuttall ME, Hung H-H, Blake SM, Grodzinsky AJ, Lark MW. 2000. Injurious mechanical compression of bovine articular cartilage induces chondrocyte apoptosis. *Arch Biochem Biophys* 381:205-212.

Loeser RF. 1993. Integrin-mediated attachment of articular chondrocytes to extracellular matrix. *Arth Rheum* 36:1103-1110.

Lohmander LS. 1994. Articular cartilage and osteoarthritis. The role of molecular markers to monitor breakdown, repair and disease. *J Anat* 184:477-492.

Lotz M, Hashimoto S, Kuhn K. 1999. Mechanism of chondrocyte apoptosis. *Osteoarthritis Cartilage* 7: 389-391

Lust G, Summers BA. 1984. Early, asymptomatic state of degenerative joint disease in canine hip joints. *Am J Vet Res* 42: 1849-1855.

Magnusson C, Vaux DL. 1999. Signalling by CD95 and TNF receptors: non only life and death. *Immunol Cell Biol* 77:41-46.

Maniotis AJ, Chen CS, Ingber DE. 1997. Demonstration of mechanical connections between integrins, cytoskeletal filaments, and nucleoplasm that stabilize nuclear structure. *Proc Natl Acad Sci USA* 94: 849-854.

Mansour JM, Mow VC. 1976. The permeability of articular cartilage under compressive strain and at high pressures. *The Journal of Bone and Joint Surgery* 58A: 509-516.

Maroudas A. 1980. *Studies in joint disease I*. Eds. A Maroudas and EJ Holborow. Pitman Medical, Tunbridge Wells, pp 59-69.

Martin SJ, Reutelingsperger CP, McGahon AJ, Rader JA, Schie RC, van LaFace DM, Green DR. 1995. Early redistribution of plasma membrane phosphatidylserine is a general feature of apoptosis regardless of the initiating stimulus: inhibition by overexpression of Bcl-2 and Ab1. *J Exp Med* 182:1545-1556.

Matsuo M, Nishida K, Yoshida A, Murakami T, Inoue H. 2001. Expression of caspase-3 and -9 relevant to cartilage destruction and chondrocyte apoptosis in human osteoarthritic cartilage. *Acta Med Okayama* 55:333-340.

McCarthy NJ, Whyte MK, Gilbert CS, Evan GI. 1997. Inhibition of Ced-3/Ice-related proteases does not prevent cell death induced by oncogens, DNA damage, or the Bcl-2 homologue Bak. *J Cell Biol* 136:215-227.

McIlwraith CW, Trotter GW. 1996. Joint disease in the horse. WB Saunders, Philadelphia, pp 58-62, 87-91.

Miwa M, Saura R, Hirata S, Hayashi Y, Mizuno K, Itoh H. 2000. Induction of apoptosis in bovine articular chondrocyte by prostaglandin E2 through camp-dependent pathway. *Osteoarthritis Cartilage* 8:17-24.

Mills JC, Stone NC, Erhardt J, Pittman RN. 1998. Apoptotic membrane blebbing is regulated by myosin light chain phosphorylation. *J Cell Biol* 140:627-636.

Mow VC, Holmes MH, Lai WM. 1984. Fluid transport and mechanical properties of articular cartilage: a review. *J Biomechanics* 17: 377-394.

Mow VC, Raticliffe A, Poole AR. 1992. Cartilage and diarthrodial joints as paradigms for hierarchical materials and structures. *Biomaterials*. 13: 67-97.

Mow VC, Wang CC, Hung CT. 1999. The extracellular matrix, interstitial fluid and ions as a mechanical signal transducer in articular cartilage. *Osteoarthritis Cartilage* 7:41-58.

Nagata S. 1997. Apoptosis by death factor. *Cell* 88:355-365.

Nevitt MC and Lane N. 1999. Body weight and osteoarthritis. *Am J Med* 107: 632-633.

Nevitt MC, Lane NE, Scott JC, Hochberg MC, Pressman AR, Genant HK, Cummings SR. 1995. Radiographic osteoarthritis of the hip and bone mineral density. *Arthritis Rheum* 38: 907-916.

Nicholson DW, Thornberry NA. 1997. Caspases: killer proteases. *Trends Biochem Sci* 22:299-306.

Nicotera P and Leist M. 1997. Energy supply and the shape of death in neurons and lymphoid cells. *Cell Death Differ* 4: 435-442.

Papassotiropoulos A, Ludwig M, Naib-Majani W, Rao GS. 1996. Induction of apoptosis and secondary necrosis in rat dorsal root ganglion cell cultures by oxidized low density lipoprotein. *Neurosci Lett* 209:33-36.

Patston PA, Gettins P, Beechem J, Schapira M. 1991. Mechanism of serpin action: evidence that C1 inhibitor functions as a suicide substrate. *Biochemistry* 30:8876-8882.

Pelletier J-R, Javanovic D, Fernandes JC, Manning P, Connor JR, Currie MG, Di Mattista JA, Martel-Pelletier J. 1998. Reduced progression of experimental osteoarthritis in vivo by selective inhibition of inducible nitric oxide synthase. *Arth Rheum* 41:1275-1286.

Pelletier J-R, Jovanovic DV, Lascau-Coman V, Fernandes JC, Manning PT, Connor JR. 2000. Selective inhibition of inducible nitric oxide synthase reduces progression of experimental osteoarthritis in vivo. Possible link with the reduction in chondrocyte apoptosis and caspase-3 level. *Arth Rheum* 43:1290-1299.

Perka C, Spitzer R-S, Lindenhayn K, Sittinger M, Schultz O. 2000. Matrix-mixed culture: New methodology for chondrocyte culture and preparation of cartilage transplants. *J Biomed Mater Res* 49:305-311.

Porter AG, Janicke RU. 1999. Emerging roles of caspases-3 in apoptosis. *Cell Death Differ* 6:99-104.

Poole AR. 1992. Chondrons. The chondrocyte and its pericellular environment. In *articular cartilage and osteoarthritis*. Eds. KE Kuettner, R Schleyerbach, JG Peyron, VC Hascall. Raven Press, New York, pp 201-220

Ratcliffe A, Shurety W, Carterson B. 1993. The quantitation of a native chondrotin sulfate epitope in synovial fluid lavages and articular cartilage from canine experimental osteoarthritis and disuse atrophy. *Arth Rheum* 36: 543-551.

Rizkalla G, Reiner A, Bogoch E, Poole AR. 1992. Studies of the articular cartilage proteoglycan aggrecan in health and osteoarthritis. Evidence for molecular heterogeneity and extensive molecular changes in disease. *J Clin Invest* 90:2268-2277.

Rossdale PD, Hopes R, Wingfield-Digb NJ. 1985. Epidemiological study of wastage among racehorses 1982 and 1983. *Vet Rec* 116:66-69.

Ruoslahti E, Reed JC. 1994. Anchorage dependence, integrins, and apoptosis. *Cell* 77:477-478.

Sabatini M, Rolland G, Leonce S, Thomas M, Lesur C, Perez V, de Nanteuil G, Bonnet J. 2000. Effects of ceramide on apoptosis, proteoglycan degradation, and matrix metalloproteinase expression in rabbit articular cartilage. *Biochem Biophys Res Commun* 267:438-444.

Saikumar P, Dong Z, Weinberg JM, Venkatachalam MA. 1998. Mechanism of cell death in hypoxia/reoxygenation injury. *Oncogene* 17:251-264.

Saikumar P, Dong Z, Mikhailov V, Denton M, Weinberg JM, Venkatachalam MA. 1999. Apoptosis: Definition, mechanisms, and relevance to disease. *Am J Med* 107:489-506.

Salter RB, Simmonds DF, Malcolm BW, Rumble EJ, MacMichael D, Clements ND. 1980. The biological effect of continuous passive motion on the healing of fullthickness defects in articular cartilage. *J Bone Jt Surg* 62A:1232-1251.

Sandmark H, Hogstedt C, Lewold S, Vingard E. 1999. Osteoarthritis of the knee in men and women in association with overweight, smoking, and hormone therapy. *Ann Rheum Dis.* 58: 151-155.

Savill J. 1997. Apoptosis in resolution of inflammation. *J Leukoc Biol* 61:375-380.

Savill J. 1998. Phagocytic docking without shocking. *Nature* 392:442-443.

Saxne T, Heinegard D, Wolheim FA. 1987. Cartilage proteoglycans in synovial fluid and serum in patients with inflammatory joint disease: relation to systemic treatment. *Arth Rheum* 30: 972-979.

Schendel S, Azimov R, Rawlowski K, Godzik A, Kagan B, Reed J. 1999. Ion channel activity of the BH3 only Bcl-2 family member, BID. *J Biol Chem* 274:21932-21936.

Scher DM, Stoleman ES, Di Cesare E. 1996. Biologic markers of arthritis. *Am J Orthop* 25: 263-272.

Setton LA, Elliott DM, Mow VC. 1999. Altered mechanics of cartilage with osteoarthritis: human osteoarthritis and an experimental model of joint degeneration. *Osteoarthritis and Cartilage* 7: 2-14.

Setton LA, Zhu WB, Mow VC. 1993. The biphasic poroelastic behavior of articular cartilage: role of the surface zone in governing the compressive behavior. *J Biomechanics* 26: 581-592.

Sharma L, Lou C, Cahue S, Dunlop DD. 2000. The mechanism of the effect of obesity in knee osteoarthritis. The mediating role of malalignment. *Arthritis Rheum.* 43: 568-575.

Shimizu S, Narita M, Tsujimoto Y. 1999. Bcl-2 family proteins regulate the release of apoptogenic cytochrome c by the mitochondrial channel VDAC. *Nature.* 399:483-487.

Silverman B, Cawston TE, Page Thomas DP, Dingle JT, Hazleman BL. 1990. The sulphated glycosaminoglycan levels in synovial fluid aspirates in patients with acute and chronic joint disease. *Br J Rheumatol* 29: 340-344.

Smith CA, Farrah T, Goodwin RG. 1994. The TNF receptor superfamily of cellular and viral proteins: activation, costimulation, and death. *Cell* 76:959-962.

Spreng D, Sigrist N, Jungi T, Busato A, Lang J, Pfister H, Schawalder P. 2000. Nitric oxide metabolite production in the cranial cruciate ligament, synovial membrane, and articular cartilage of dogs with cranial cruciate ligament rupture. *Am J Vet Res* 61:530-536.

Steinmeyer J, Ackermann B. 1999a. The effect of continuously applied cyclic mechanical loading on the fibronectin metabolism of articular cartilage explants. *Res Exp Med* 198: 247-260.

Steinmeyer J, Knue S, Raiss RX, Pelzer I. 1999b. Effects of intermittently applied cyclic loading on proteoglycan metabolism and swelling behavior of articular cartilage explants. *Osteoarthritis Cartilage*, 7: 155-164.

Stockwell RA. 1971. The interrelationship of cell density and cartilage thickness in mammalian articular cartilage. *J Anat* 109: 411-421.

Takano KJ, Takano T, Yamanouchi Y, Satou T. 1997. Pressure-induced apoptosis in human lymphoblasts. *Exp Cell Res* 235:155-160.

Tanaka Y, Yoshihara K, Itaya A, Kamiya T, Koide SS. 1984. Mechanism of the inhibition of Ca²⁺, Mg²⁺-dependent endonuclease of bull seminal plasma induced by ADP-ribosylation. *J Biol Chem* 259:6579-6585.

Teixeira CC, Mansfield K, Hertkorn C, Ischiropoulos H, Shapiro IM. 2001. Phosphate-induced chondrocyte apoptosis is linked to nitric oxide generation. *Am J Physiol Cell Physiol* 281:C833-839.

Tew SR, Kwan AP, Hann A, Thomson BM, Archer CW. 2000. The reactions of articular cartilage to experimental wounding. *Arthritis Rheum* 43:215-225.

Todhunter RJ and Lust G. 1992. Synovial joint anatomy, biology and pathobiology. In: *Equine Surgery*. Ed: JA Auer. W.B. Saunders, Philadelphia, pp 844-866.

Venn MF, Maroudas A. 1977. Chemical composition and swelling of normal and osteoarthritic femoral head cartilage. I. Chemical composition. *Clin Orthop Rel Res* 36: 121-129.

Vieira HL, Belzacq AS, Haouzi D, Dernassola F, Cohen I, Jacotot E, Ferri KF, El Mamel C, Bartle LM, Melino G, Brenner C, Goldmacher V, Kroemer G. 2001. The adenine nucleotide translocator: a target of nitric oxide, peroxynitrite, and 4-hydroxynonenal. *Oncogene* 20:4305-4316.

Wang N, Ingber DE. 1994. Control of cytoskeletal mechanics by extracellular matrix, cell shape, and mechanical tension. *Biophys J* 66: 2181-2189.

Wluka AE, Davis SR, Bailey M, Stuckey SL, Cicuttini FM. 2001. Users of oestrogen replacement therapy have more knee cartilage than non-users. *Ann Rheum Dis*. 60: 332-336.

Woessner JF. 1991. Matrix metalloproteinases and their inhibitors in connective tissue remodeling. *FASEB J* 5:2145-2154.

Wright MO, Nishida K, Bavington C, Godolphin JL, Dunne E, Walmsley S, Jobanputra P, Nuki G, Salter DM. 1997. Hyperpolarisation of cultured human chondrocytes following cyclical pressure-induced strain: Evidence of a role for alpha5 beta1 integrin as a chondrocyte mechanoreceptor. *J Orthop Res* 15: 742-747

Yabuki M, Tsutsui K, Horton AA, Yoshioka T, Utsumi K. 2000. Caspase activation and cytochrome c release during HL-60 cell apoptosis induced by a nitric oxide donor. *Free Rad Res* 32:507-514.

Yang J, Liu Z, Bhalla K, Kim CN, Ibrado AM, Cai J, Peng TI, Jones DP, Wang X. 1997. Prevention of apoptosis by Bcl-2: release of cytochrome c from mitochondria blocked. *Science* 275:1129-1132.

Yelin E, Herrndorf A, Trupin L, Sonneborn D. 2001. A national study of medical care expenditures for musculoskeletal conditions: the impact of health insurance and managed care. *Arthritis Rheum* 44: 1160-1169.

Xie DL, Meyers R, Homandberg GA. 1992. Fibronectin fragments in osteoarthritis synovial fluid. *J Rheumatol* 19:1448-1452.

Xie DL, Hui F, Homandberg GA. 1993. Fibronectin fragments alter matrix protein synthesis in cartilage cultured in vitro. *Arch Biochem Biophys* 307:110-118.

VITA

Dae Young Kim was born in Taebaek, Kangwon-Do, Republic of Korea, in 1968 and was raised in Seoul, Korea. He was a graduate of Nam-Kang High School, Seoul, Korea, in 1987. Following high school he attended the College of Veterinary Medicine, Seoul National University, Korea, and graduated with his D.V.M. degree in 1991. He obtained a Master of Science degree in veterinary pathology from Seoul National University in 1995. His thesis was entitled "Point mutation of H-*ras* oncogene in N-butyl-N-(4-hydroxybutyl)nitrosamine (BBN)-induced urinary bladder tumors in the rat". Most of his thesis project was performed at the National Institute of Safety Research in Korea, where he gained experience in laboratory animal pathology, electron microscopy, and molecular biology. In 1996, he worked as a research associate in the Department of Veterinary Pathology, College of Veterinary Medicine, Seoul National University on detection of alkylating damage in Korean gastric cancer using a ³²P- postlabelling assay. Since 1997, he has been a veterinary pathology resident/doctoral degree candidate in the Department of Pathobiological Sciences, School of Veterinary Medicine at the Louisiana State University. He is married to Yumi and has a 6-year-old son, Mingu.